

An Underwater Acoustic OFDM Communication System with Robust Doppler Compensation

Taisaku Suzuki[†], Tomohisa Wada^{††}, Hiromasa Yamada^{†††}, and Shigeo Nakagawa^{†††},

[†]National Institute of Technology, Okinawa College, ^{††}University of the Ryukyus, ^{†††}Oki Seatec Co., Ltd

Summary

This paper proposes an underwater acoustic QPSK/16QAM/64QAM OFDM communication system with robust Doppler compensation. This system has OFDM receiver which possesses additional time domain signal processing such as signal shrink-expansion processing and Doppler shift compensation capabilities in order to mitigate Doppler shift effect caused by transmitter and/or receiver movement. The outputs of the four OFDM receivers are further combined by frequency domain diversity combiner with Maximum-Ratio Combining (MRC) algorithm to improve Signal to Noise Ratio. Our system utilized 20-28[kHz] ultrasonic OFDM channel and subcarrier spacing of 100[Hz]. Total number of sub-carriers is 81. QPSK/16QAM/64QAM modulations are used. The proposed system is verified by computer simulations and ocean measurement at Shizuoka prefecture in Japan. By performing experiment in the ocean at depth of 1000m, BER of approximately less than 1E-2 has been successfully obtained using 64QAM, and surface ship received a taken image from 1000m deep camera system.

Key words:

Underwater, Acoustic Communication, OFDM, MRC, Doppler Compensation

1. Introduction

ROV(Remotely Operated Vehicle) and AUV(Autonomous Underwater Vehicle) are equipment operated in underwater to develop oceans such as explore marine natural resources and research on marine organism and so on. In the usual case of operated ROV/AUV, operator transmit the digital control data of the opposite direction from surface ships to equipment and/or surface ships receive the data acquired by the equipment such as image or movie data via wired cable. The underwater communication by using wired cable causes restriction of movable range for equipment occasionally. Therefore the underwater wireless communication is needed to exchange rapid information between ROV, AUV, divers, and ships efficiently. The moving of equipment and/or surface ship causes Doppler shift effect during underwater wireless communication, so the receiver of each side is necessary to have the signal processing for Doppler shift compensation capabilities.

In this paper, we propose the underwater acoustic OFDM (Orthogonal Frequency Division Multiplexing) communication system with robust Doppler compensation.

This system has OFDM receivers with processing additional time domain signal processing such as signal shrink-expansion processing and Doppler shift compensation capabilities.

2. PROPOSED SYSTEM

2.1 System Block Diagram

Fig. 1 shows underwater acoustic communication network. Because of the wave transmitted from transmitter to receiver is reflected by the bottom of the ocean, the surface and the other objects, many multipath propagation happens in the ocean. And transmitter and/or receiver move in the ocean, so Doppler shift effect occurred, therefore underwater acoustic communication is inhibited by multiple reflection. Our proposed system will be utilized efficiently even in such an underwater environment.

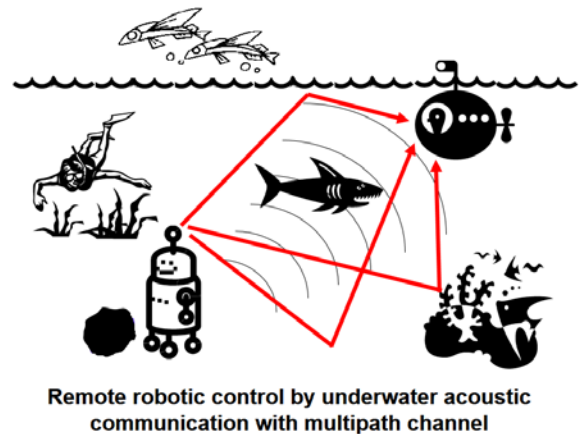

Fig. 1 Underwater acoustic communication network.

Fig. 2 shows examples of target applications of this system to investigate deep sea natural resources and to protect rich natural environments using underwater acoustic communication in order to control the robot and exchange high bandwidth digital data such as real time distribution of moving picture and audio.

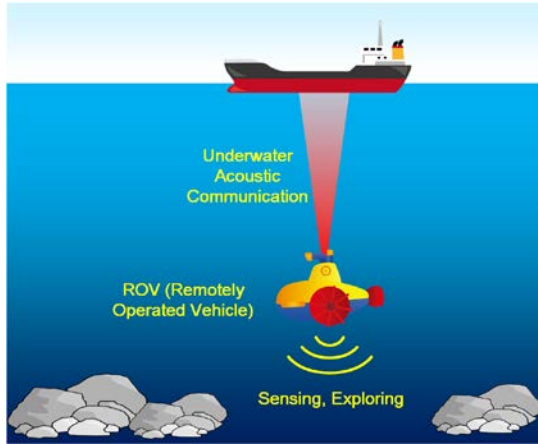

Fig. 2 Application example of this system.

Fig. 3 shows the block diagram of this proposed underwater communication system. This system consists of a transmitter equipped 1 branch TX transducer and a receiver equipped 4 branch integrated RX transducers. The lower side of the figure corresponds to the transmitter TX and the upper side is receiver RX. The TX is typical OFDM transmitter while the RX has additional Time-Domain Doppler compensation capabilities. In TX side, bit data are modulated by using QPSK / 16QAM / 64QAM digital modulations, and BPSK modulated pilot symbol are inserted in order to measure time-varying channel condition. Guard Interval (GI) of 2.8125 ms is attached to the head of each OFDM symbol. The GI length is carefully determined by taking multi-path delay distribution. Then the baseband signal is up-converted to 24 kHz center frequency, and finally the output of TX is emitted into underwater channel via TX transducer with average power of 166dB.

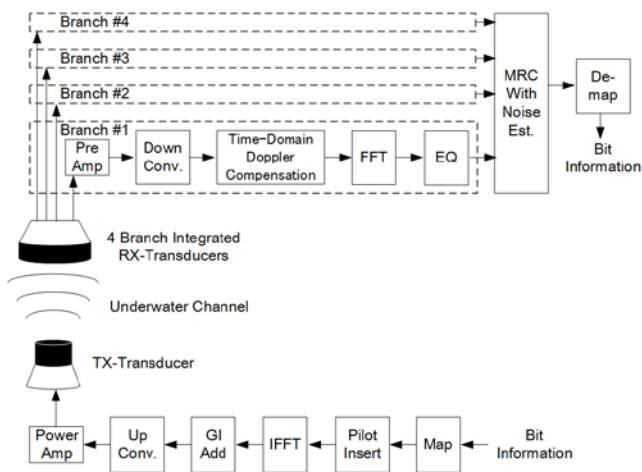

Fig. 3 Block diagram of proposed communication system.

Fig. 4 shows the block diagram of one branch receiver in detail. The Time-Domain Doppler compensation block in Fig. 3 corresponds to Shrink-Expansion Factor detect, Resample and De-rotation, and fine Phase Shift Compensation. Those two stages signal processing have realized robust communication system which can use even 64QAM higher modulation. After the fine Phase-Shift compensation, 3rd FFT is performed. Then channel estimation processing is performed to generate a channel transfer function (CTF). By dividing the 3rd FFT output by CTF, equalization process is performed to recover correct constellations. Finally, Maximum-Ratio Combining (MRC) [4-6] is performed for diversity combining [1-3] by using 4 RX outputs as shown in Fig. 3.

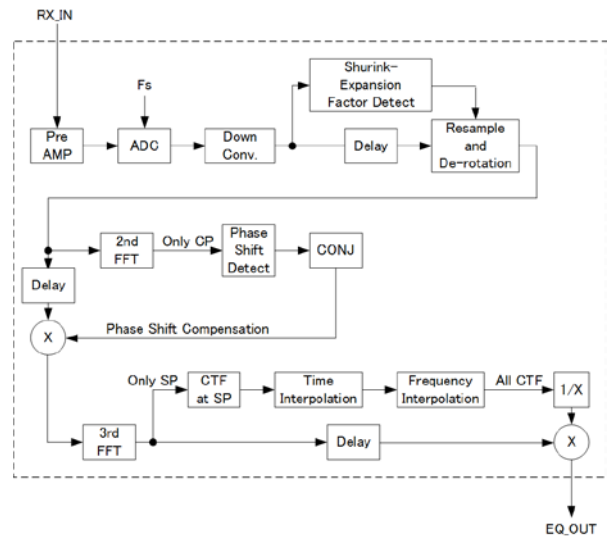

Fig. 4 Block diagram of 1 branch receiver.

2.2 Time-Frequency Representation

Fig. 5 shows the time-frequency representation of the OFDM system. The number of total sub-carriers in one OFDM symbol is 81. The 41 symbols of Scattered Pilot (SP), which are placed at all even number sub-carriers, are allocated to one OFDM symbol in every 4 OFDM symbol intervals as shown by the triangle. The SP is used for channel estimation to generate channel transfer function (CTF). In order to obtain whole time-frequency grid points, CTF at SP position are interpolated in time and frequency axis. The 16 symbols of Continuous Pilot (CP) are allocated to each OFDM symbol randomly in even carrier numbers as shown by rectangles. The CP is used to calculate fine Phase Shift Estimation for fine phase compensation. The other white circles correspond to data sub-carriers, which are modulated by QPSK / 16QAM / 64QAM.

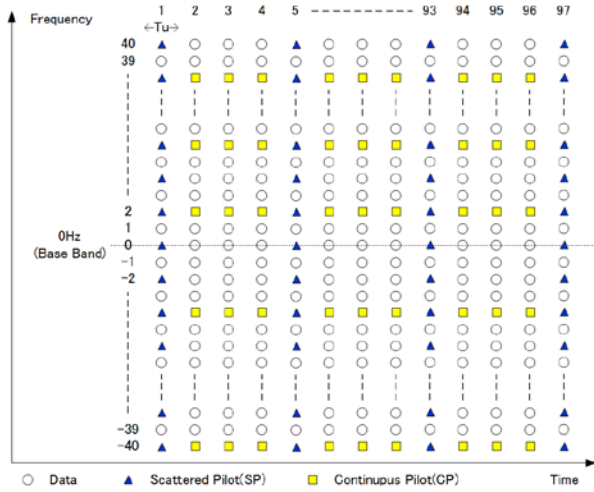

Fig. 5 Time Frequency diagram for OFDM.

2.3 Shrink-Expansion processing

In order to mitigate Doppler shift effect caused by transmitter and/or receiver movement, time domain signal is either shrunk or expanded. As shown in Fig. 4, the received signal is amplified and sampled using sampling frequency $F_s=102.4\text{kHz}$. Fig. 6(a) shows a Shrink-Expansion Factor β detector. Since SP is placed every even sub-carrier index, the delay profile can be computed as shown in Fig. 6(b). The peak position (PP) of the profile indicates the starting time point of the effective OFDM symbol. Since the PPs are available every 4 OFDM symbol, by comparing current $PP(n)$ with previous $PP(n-4)$, sampling interval $T_s (=1/F_s)$ drift can be computed. Then Shrink-Expansion Factor β can be obtained such as

$$T_s' = \beta \cdot T_s \quad (1)$$

Here, T_s is system sampling Interval and T_s' is correct sampling interval. After the detection, resample operation is performed as shown in Fig. 7. Since the resample operation needs to computer interpolated point from original samples, 13 tap filter is used. De-rotation operation is also required in the case of $\beta \neq 1$, because Down-Conversion processing is to multiply received signal with $\exp(-j2\pi F_c n T_s)$ in order to shift the center frequency to 0Hz. At the case of $\beta \neq 1$, the Down-Converted center frequency has the following Difference as shown in equation (2).

$$Diff = e^{-j2\pi f_c n (T_s - T_s')} = e^{-j2\pi f_c n T_s' (1-\beta)/\beta} \quad (2)$$

Then, additional de-rotation multiply of conjugate of Diff is required.

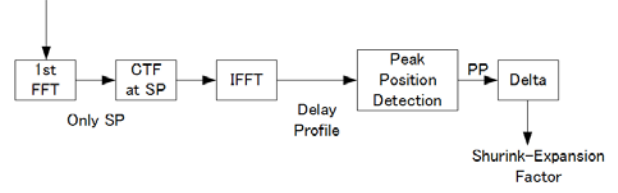

(a) Shurink-Expansion Factor Detector

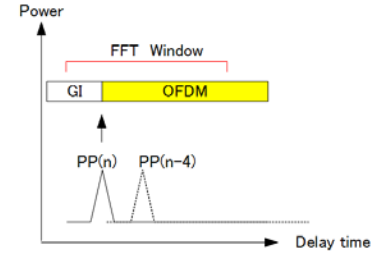

(b) Delay Profiles for symbol number n and n-4

Fig. 6 Shrink Expansion Function.

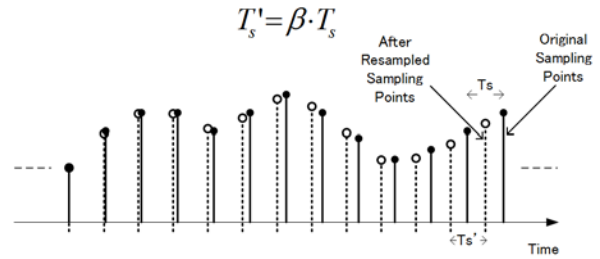

Fig. 7 Resample operation.

The Table 1 indicates detail system features. The system utilizes 20 to 28 kHz (8 kHz bandwidth) ultrasonic sound for OFDM communication and subcarrier spacing of 100 Hz. The OFDM symbol length is 10.0 ms, which corresponds to 1024 points of samples. Total number of subcarriers are 81.

Table 1: OFDM System Parameters

Parameters	Value
TX-RX Elements	1 TX and 4 RX Transducer
Sampling Frequency F_s	102.4 KHz
TX Center Frequency F_c	24000 Hz
Band Width	8000 Hz
FFT Size	1024
OFDM symbol length T	10.0 ms
GI length	2.8125 ms
Sub Carrier Spacing	100 Hz
Number of Sub Carrier	81
Average TX power	166dB
Max. Data Rate	27.5Kbps (64QAM)

3. EXPERIMENTAL RESULTS

3.1 Burge Experimental Result

Fig. 8 shows the Burge experiment scene of the proposed underwater acoustic OFDM communication system. Burge experiment was performed at Suruga Bay in Shizuoka prefecture, Japan. Fig. 9 shows the photograph of Burge. The transmitter with 1 TX transducer is fixed at 30m seabed by hanging with a wire from the bottom of the barge. The receiver with 4 RX transducers is moved upward and downward repeatedly from surface to seabed by using a crane automatically and receives the OFDM signal from the TX. The moving speed of the RX is roughly maximum 1m/sec.

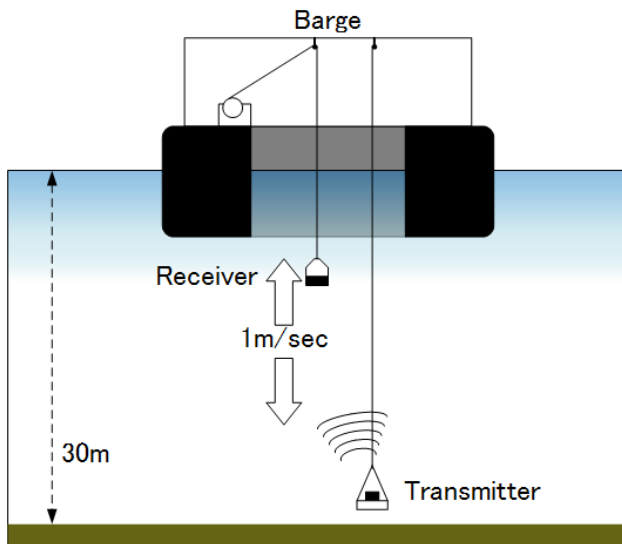

Fig. 8 Burge Experimental Scene.



Fig. 9: Photograph of Burge.

Fig. 10 shows the 16QAM constellation plot without Doppler Compensation. Because of disable the Doppler Compensation capabilities, the 16QAM constellation looks suffers lower SNR conditions. Fig. 11 and 12 shows the 16QAM and 64QAM constellation plot with Doppler Compensation. The constellation plot always get clean even in receiver moved upward and downward environment.

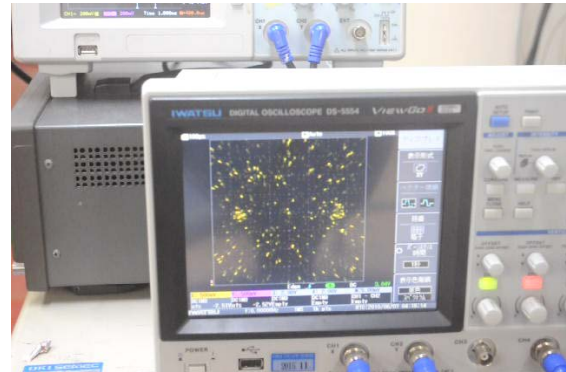

Fig. 10 16QAM constellation without Doppler Compensation (Receiver moving).

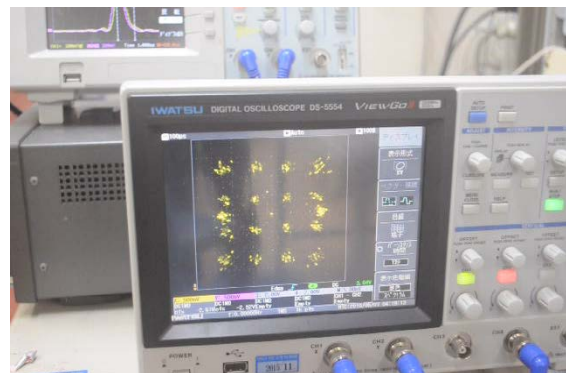

Fig. 11 16QAM constellation with Doppler Compensation (Receiver moving).



Fig. 12: 64QAM constellation with Doppler Compensation (Receiver moving).

3.2 Computer Simulation Result

Fig. 13 shows a graph on CNR vs BER (Bit Error Rate) in case of QPSK modulation by using MATLAB software. This figure shows BER comparison between Doppler Compensation ON and OFF. Dotted lines are corresponds to Doppler Compensation OFF in the case of receiver moved upward and downward. Because of Doppler shift effect caused by receiver movement, the BER performance is bad. Dashed lines are corresponds to Doppler Compensation ON. There is a significant improvement in the BER performance, and has a same BER curves for receiver not moving case. Fig. 14 shows a graph in case of 16QAM modulation. As in the case of QPSK modulation, there is a significant improvement in the BER performance. Fig. 15 shows a graph in case of 64QAM modulation. In this case, Doppler Compensation was not sufficient and error floor appears.

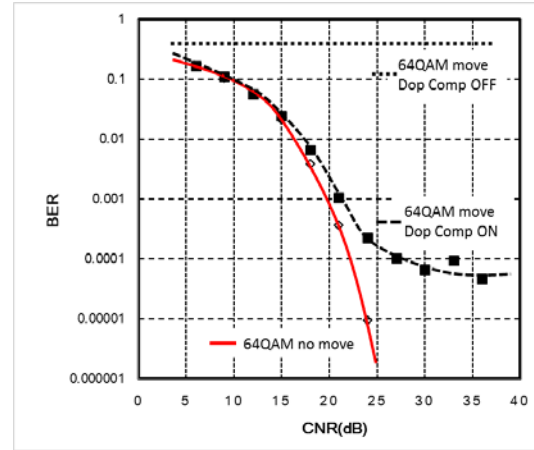

Fig. 15 Simulation Result (64QAM modulation).

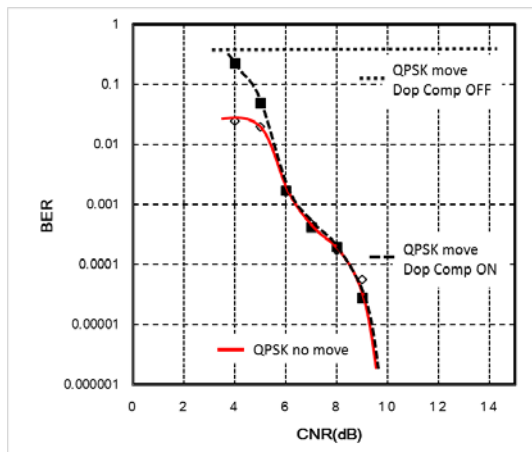

Fig. 13 Simulation Result (QPSK modulation).

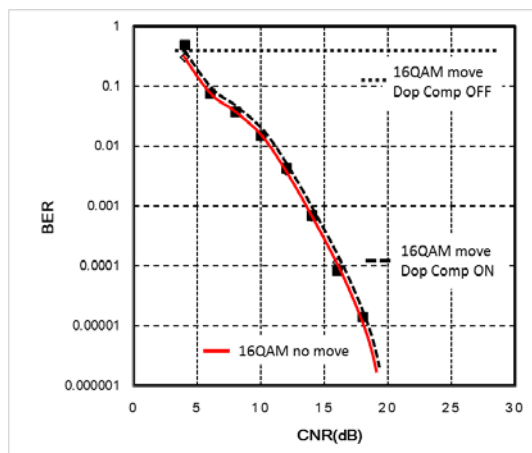

Fig. 14: Simulation Result (16QAM modulation).

3.3 Deep Ocean Experimental Result

Fig. 16 shows the Deep ocean experiment scene of the proposed underwater acoustic OFDM communication system. The transmitter with 1 TX transducer is sank to the 1000m deep seabed using a crane from the ship. The moving speed of the TX is roughly maximum 1m/sec. The TX transducer regularly transmits the OFDM signal which carries photo JPEG data modulated by QPSK / 16QAM / 64QAM digital modulations. The camera is equipped in pressure-resistant glass case in order take photos at deep sea. The receiver with 4 RX transducers is fixed to the ship and receives the OFDM signal from the moving TX. Fig. 17 and 18 are Transmitter with camera system on the ship hung by crane and 4 integrated transduces photos.

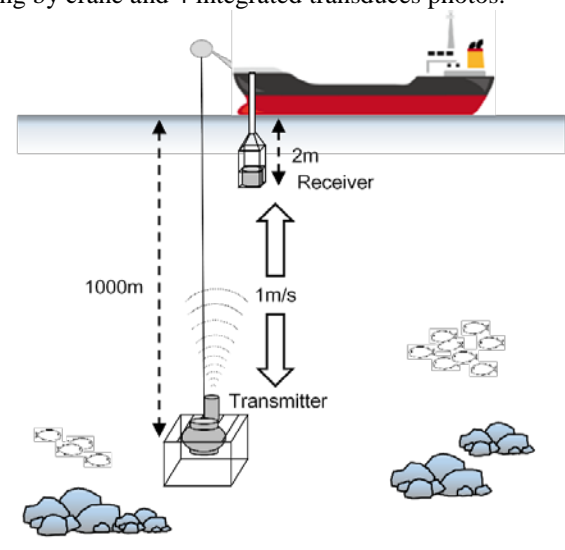

Fig. 16 Deep Ocean Experimental Scene.

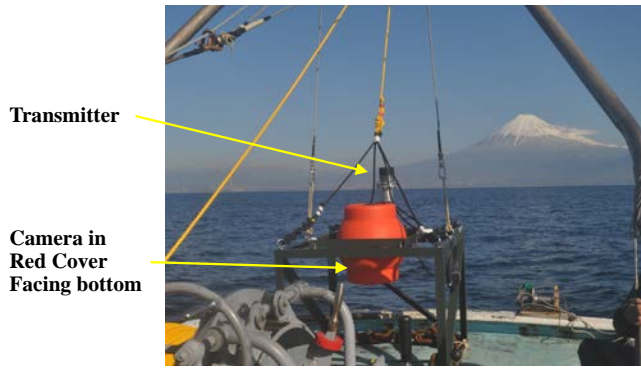

Fig. 17 Tx Transducer and camera system.



Fig. 19 64QAM constellation at 1000m depth.



Fig. 18 Rx 4 branches integrated Transducer.

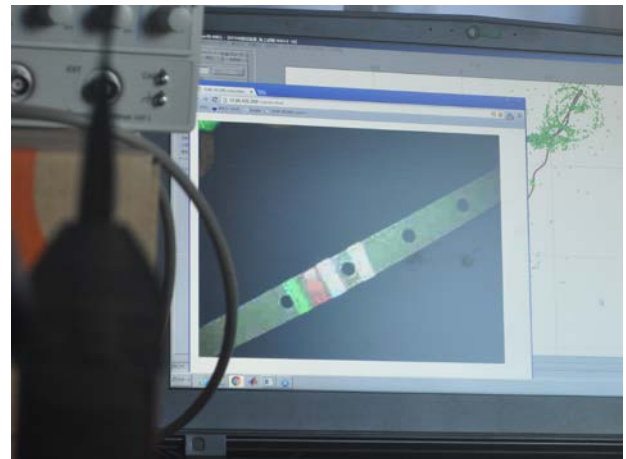

Fig. 20 Received image from 1000m deep camera.

Ocean experiment was performed at Suruga Bay in Shizuoka prefecture, Japan. Fig. 19 and 20 shows 64QAM measured constellation at 1000 depth and a taken image from 1000m deep TX (transferred by QPSK modulation because of error free).

Finally, Fig. 21 shows a graph on Packet number vs BER (Bit Error Rates) in case of using 64QAM modulations. As packet number increases in the left half, the depth of TX increases and BER also increases. At the peak depth of 1000m, BER of approximately less than $1E-2$ has been successfully obtained using 64QAM without any error correction. In addition, the TX moving speed is also indicated in the figure such as 0.54m/sec to 0.95m/sec. Robustness of two stages Doppler compensation in the proposed system with 64QAM modulation has been successfully confirmed.

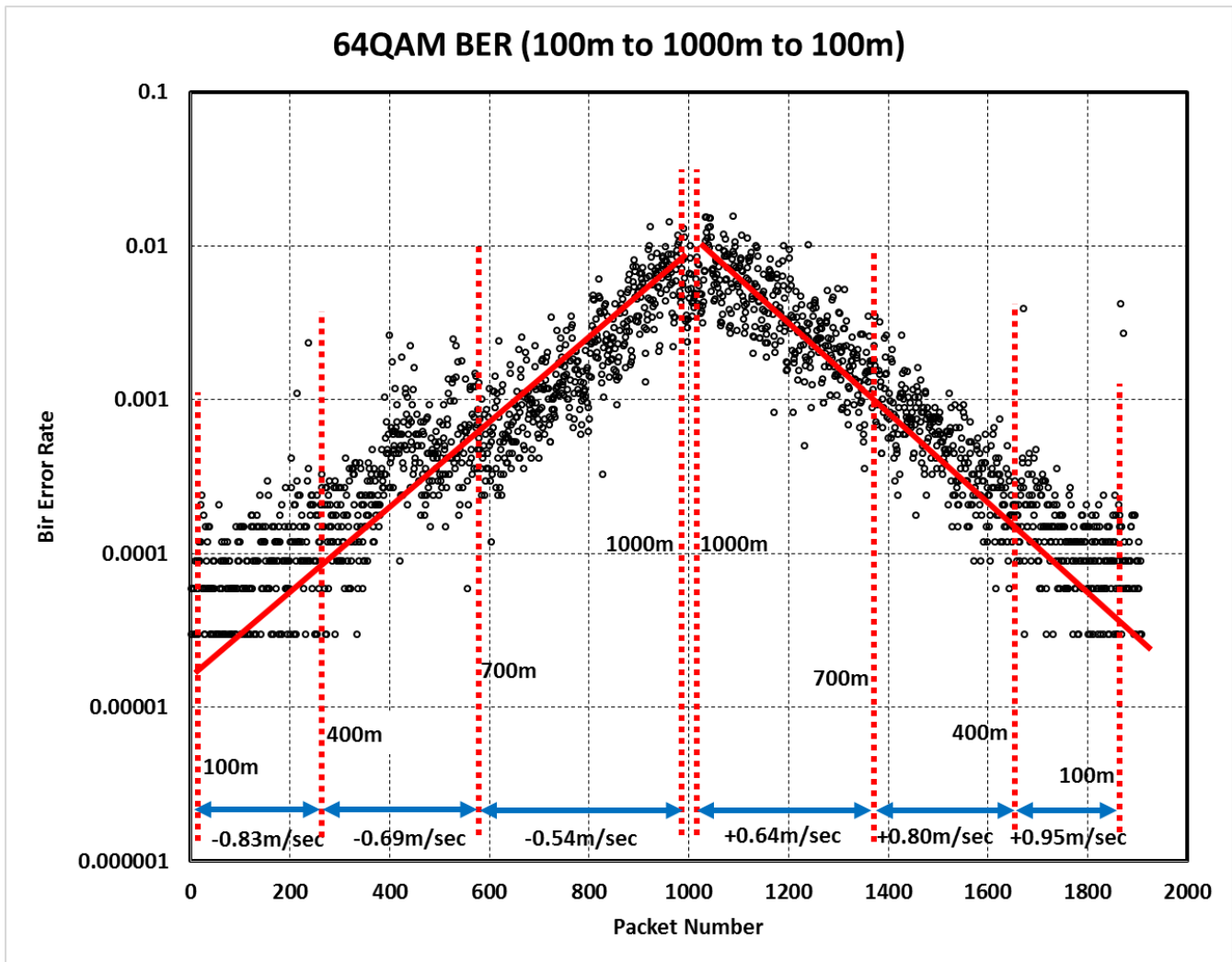

Fig. 21: 64QAM BER at Received image from 1000m deep camera.

4. CONCLUSION

An underwater acoustic OFDM communication system with Robust Doppler Compensation is proposed. It can transmit image or movie data from deep sea AUV etc. to surface ship. In order to mitigate Doppler shift effect caused by transmitter and/or receiver movement, the OFDM receiver possesses additional time domain signal processing such as signal shrink-expansion processing and Doppler shift compensation capabilities. The outputs of the four OFDM receivers are further combined by frequency domain diversity combiner with Maximum-Ratio Combining (MRC) algorithm to improve Signal to Noise ratio.

The proposed communication system is verified by Ocean measurement at Shizuoka prefecture in Japan. The system

utilized 20-28[kHz] ultrasonic OFDM channel and subcarrier spacing of 100[Hz]. Total number of sub-carriers is 81. QPSK / 16QAM / 64QAM modulations are used. By performing experiment in the ocean at depth of 1000m, BER of approximately less than $1E-2$ has been successfully obtained using 64QAM without any error correction under the TX vertical movement speed of 0.54-0.95 m/sec.

References

- [1] G. Qiao, W. Wang, R. Guo, R. Khan, and Y. Wang, "Frequency diversity for OFDM mobile communication via underwater acoustic channels", *Journal of Marine Science and Application*, vol. 11, no. 1, pp. 126-133, 2012.
- [2] G. Leus and P. A. van Walree, "Multiband OFDM for covert acoustic communications", *IEEE Journal on Selected Areas in Communications*, vol. 26, no. 9, pp. 1662-1673, 2008.

- [3] H. D. Trung and N. Van Duc, "An analysis of MIMO-OFDM for underwater communications" in Proceedings of the 3rd International Congress on Ultra Modern Telecommunications and Control Systems and Workshops (ICUMT '11), Budapest, Hungary, October 2011.
- [4] J. Gao, T. Iida, H. Mizutani et al., "The implementation of a 2/4/8 antennas configurable diversity OFDM receiver for mobile HDTV application", International Journal of Digital Multimedia Broadcasting, vol. 2009, Article ID 303627, 9 pages, 2009.
- [5] T. Koujita, T. Wada, T. Iida et al., "Evaluation of diversity combining systems for mobile reception in digital terrestrial television broadcasting", in Proceedings of the IEEE International Conference on Consumer Electronics, SESSION: 6.3 Digital Receivers I, Las Vegas, Nev, USA, January 2009.
- [6] Tomohisa Wada, Chapter 18: Diversity and error compensation in OFDM transceivers: principles and implementation, Digital Front-End in Wireless Communication and Broadcasting, Cambridge University Press, 2011.
- [7] Tran Minh Hai, Rie Saotome, Taisaku Suzuki and Tomohisa Wada, "An Acoustic OFDM System with Symbol-by-Symbol Doppler Compensation for Underwater Communication", The Scientific World Journal (Communication), Volume 2016 (2016), Article ID 7528353, 11 pages, Hindawi Publishing Corporation, 2016.
- [8] Rie Saotome, Tran Minh Hai, Yasuto Matsuda, Taisaku Suzuki, and Tomohisa Wada, "An OFDM receiver with frequency domain diversity combined impulsive noise canceller for underwater network", The Scientific World Journal, Volume 2015(2015), Article ID 841750, 10 pages, Hindawi Publishing Corporation, 2015.
- [9] Taisaku Suzuki, Hai Minh TRAN, Tomohisa Wada, "An Underwater Acoustic OFDM Communication System with Shrimp (Impulsive) Noise Cancelling", ComManTel2014 Conference, Duy Tan University, Da Nang, Vietnam, April 27-29, 2014.
- [10] Tran Minh Hai, Yasuto Matsuda, Taisaku Suzuki, Tomohisa WADA, "Ultrasonic Diversity OFDM Transceiver architecture with Impulsive Noise Cancelling for shallow sea communication", UA2014-2nd International Conference and Exhibition on Underwater Acoustics, Rodes, Greece, June 22-27 2014.
- [11] Khalifa Al-Mawali, Amin Z. Sadik, and Zahir M. Hussain, "Joint Time-domain/Frequency-domain Impulsive Noise Reduction in OFDM-based Power Line Communications", Telecommunication Networks and Applications Conference, 2008. ATNAC 2008. Australasian, pp.138-142, 2008.
- [12] Sergey V. Zhidkov, "Impulsive noise suppression in OFDM-based communication systems", IEEE Transactions on Consumer Electronics, Vol. 49, No. 4, 2003.