



Introduction to OFDM

Fire Tom Wada

Professor, Information Engineering, Univ. of the Ryukyus

Chief Scientist at Magna Design Net, Inc

wada@ie.u-ryukyu.ac.jp

<http://www.ie.u-ryukyu.ac.jp/~wada/>



What is OFDM?

- OFDM
=Orthogonal Frequency Division Multiplexing
- Many orthogonal sub-carriers are multiplexed in one symbol
 - What is the orthogonal?
 - How multiplexed?
 - What is the merit of OFDM?
 - What kinds of application?



Outline

- Background, history, application
- Review of digital modulation
- FDMA vs. Multi-carrier modulation
- Theory of OFDM
- Multi-path
- Summary



Why OFDM is getting popular ?

- State-of-the-art high bandwidth digital communication start using OFDM
 - Terrestrial Video Broadcasting in Japan and Europe
 - ADSL High Speed Modem
 - WLAN such as IEEE 802.11a/g/n
 - WiMAX as IEEE 802.16d/e
- Economical OFDM implementation become possible because of advancement in the LSI technology



Japan Terrestrial Video Broadcasting service

- ISDB-T (Integrated Services Digital Broadcasting for Terrestrial Television Broadcasting)
- Service starts on 2003/December at three major cities (Tokyo, Nagoya, Osaka)
- Full service area coverage on 2006
- 5.6MHz BW is divided into 13 segments (~430KHz BW)
- HDTV: 12 segments
- Mobile TV : 1 segment
- SDTV: 4 segment
- Analog Service will end 2011



Brief history of OFDM

- First proposal in 1950's
- Theory completed in 1960's
- DFT implementation proposed in 1970's
- Europe adopted OFDM for digital radio broadcasting in 1987
- OFDM for Terrestrial Video broadcasting in Europe and Japan
- ADSL, WLAN(802.11a)



Digital modulation basics

- Digital modulation modulates three parameters of sinusoidal signal.
- $A, \theta_k, f_c, s(t) = A \cdot \cos(2\pi \cdot f_c \cdot t + \theta_k)$
- Three type digital modulation:
 - ASK : Amplitude Shift Keying
 - PSK : Phase Shift Keying
 - FSK : Frequency Shift Keying

OFDM uses combination of ASK and PSK such as QAM, PSK

Symbol Waveform

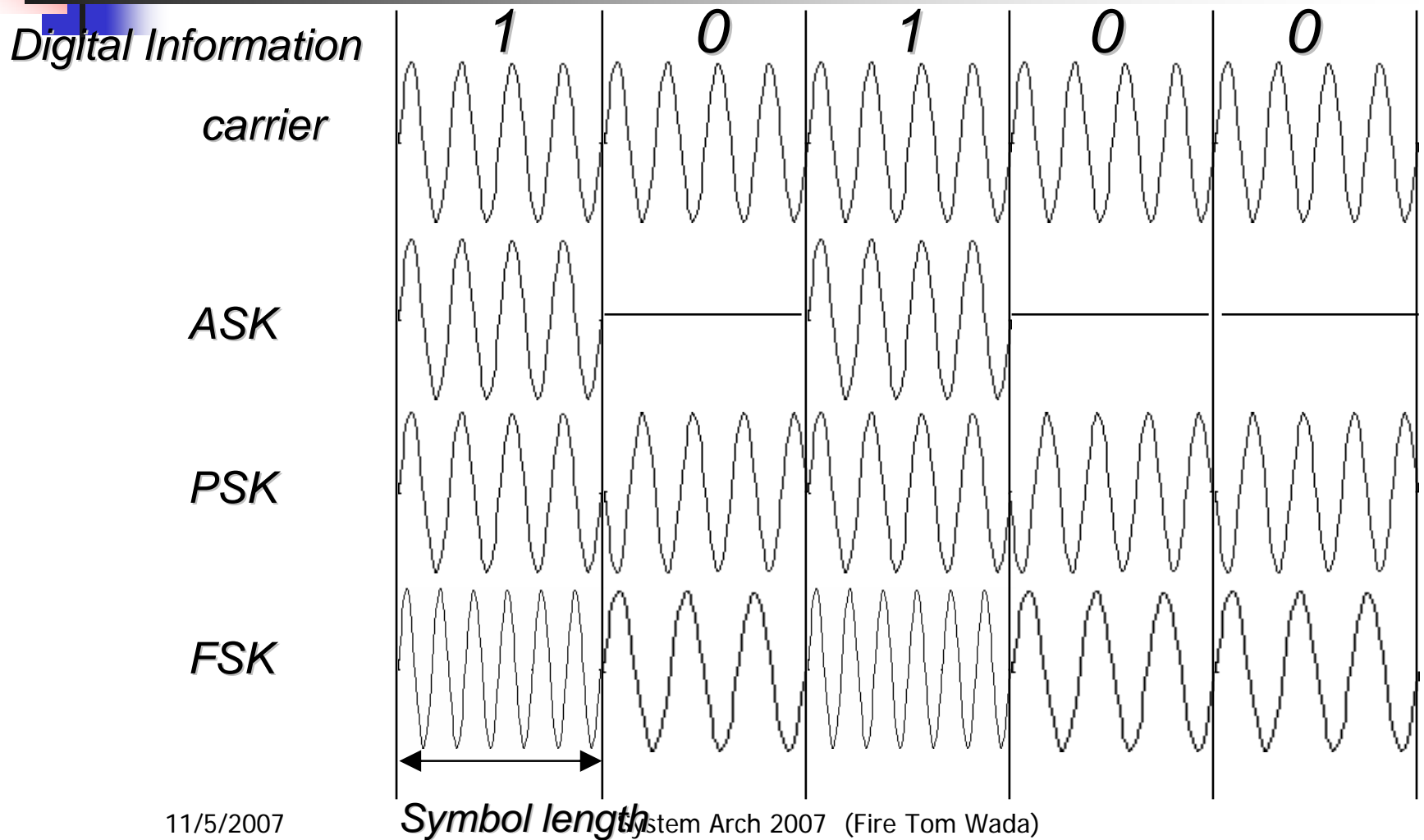

Multi bit modulation

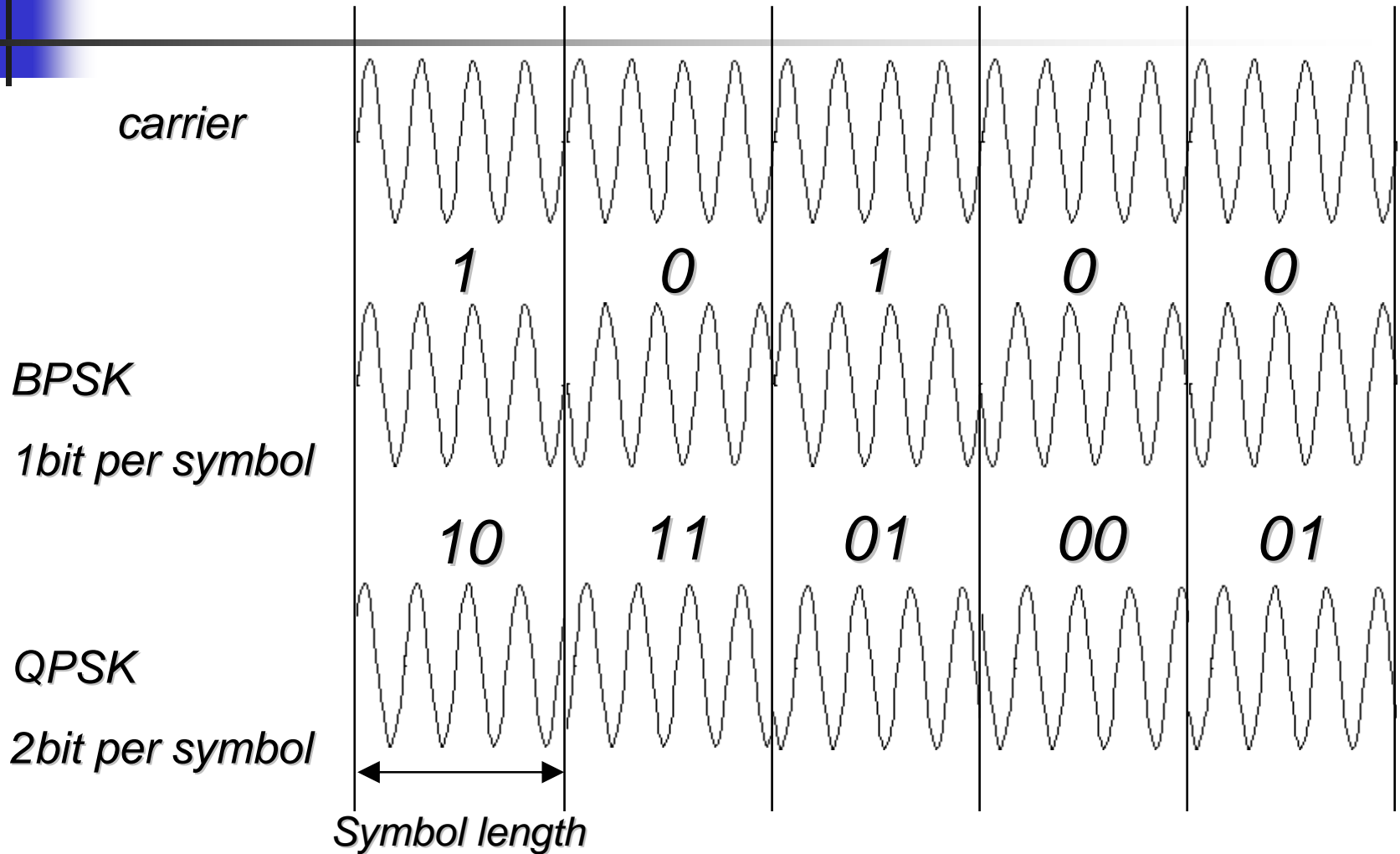

Mathematical expression of digital modulation

- Transmission signal can be expressed as follows

$$\begin{aligned} s(t) &= \cos(2\pi \cdot f_c \cdot t + \theta_k) \\ &= \cos \theta_k \cdot \cos(2\pi \cdot f_c \cdot t) - \sin \theta_k \cdot \sin(2\pi \cdot f_c \cdot t) \end{aligned}$$

$$a_k = \cos \theta_k, \quad b_k = \sin \theta_k$$

$$s(t) = \text{Re}[(a_k + jb_k)e^{j2\pi f_c \cdot t}]$$

- $s(t)$ can be expressed by complex base-band signal $(a_k + jb_k)e^{j2\pi f_c \cdot t}$

$e^{j2\pi f_c \cdot t}$ *Indicates carrier sinusoidal*

$(a_k + jb_k)$ *Digital modulation*

Digital modulation can be expressed by the complex number

Constellation map

- $(a_k + jb_k)$ is plotted on I(real)-Q(imaginary) plane

data		a_k	b_k
00	/4	$\frac{1}{\sqrt{2}}$	$\frac{1}{\sqrt{2}}$
01	3 /4	$-\frac{1}{\sqrt{2}}$	$\frac{1}{\sqrt{2}}$
11	5 /4	$-\frac{1}{\sqrt{2}}$	$-\frac{1}{\sqrt{2}}$
10	7 /4	$\frac{1}{\sqrt{2}}$	$-\frac{1}{\sqrt{2}}$

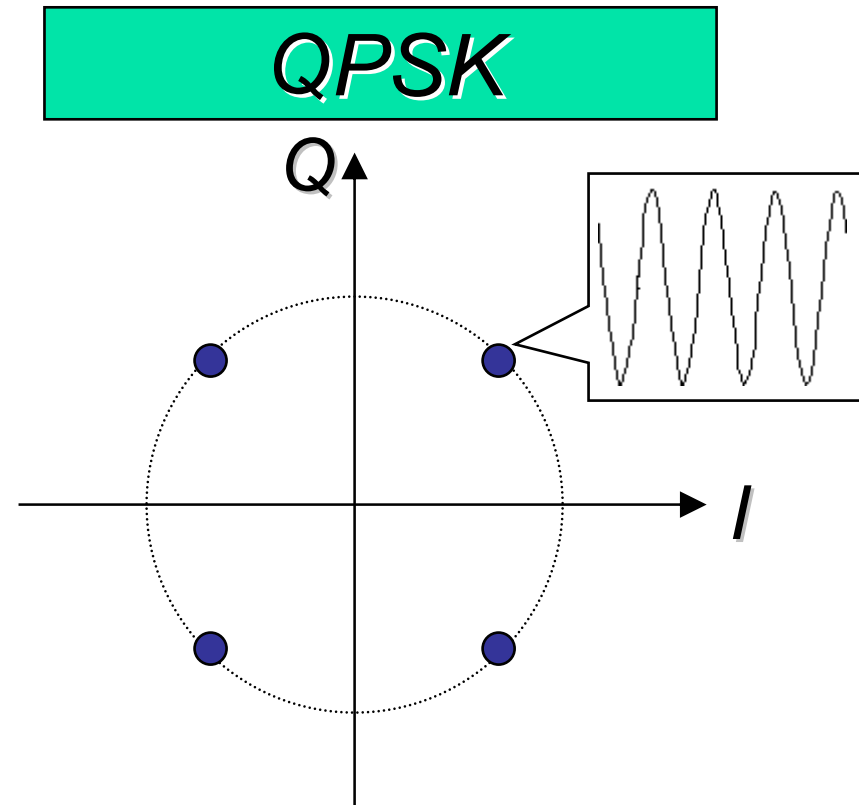

Quadrature Amplitude Modulation (QAM)

16QAM

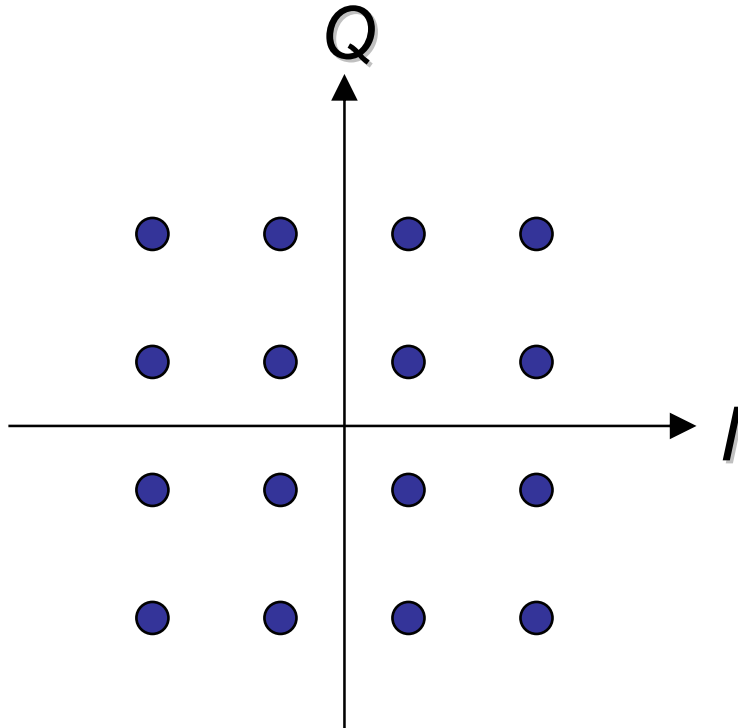

64QAM

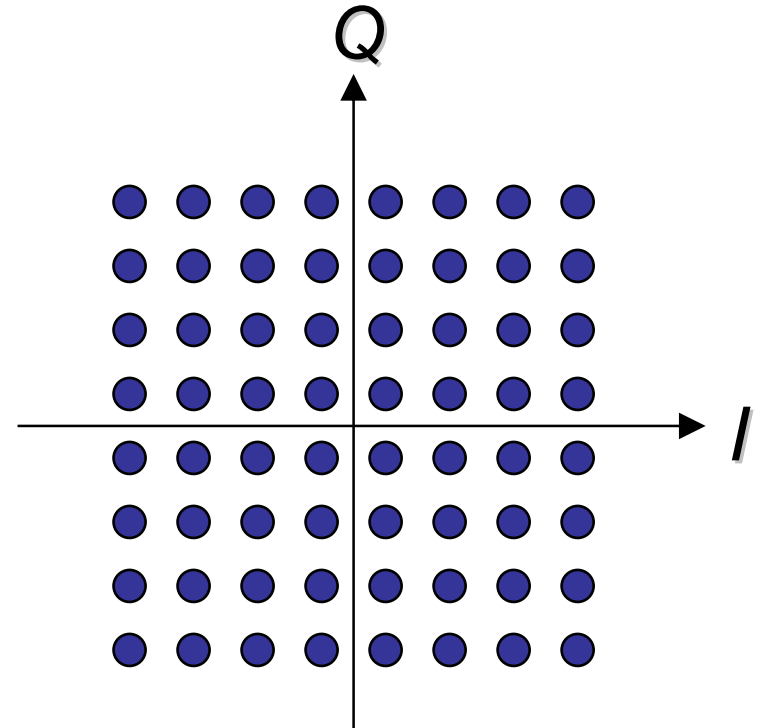

Summary of digital modulation

- Type of modulation: ASK,PSK,FSK,QAM
- OFDM uses ASK,PSK,QAM
- Digital modulation is mathematically characterized by the coefficient of complex base-band signal

$$(a_k + jb_k)$$

- Plot of the coefficients gives the constellation map

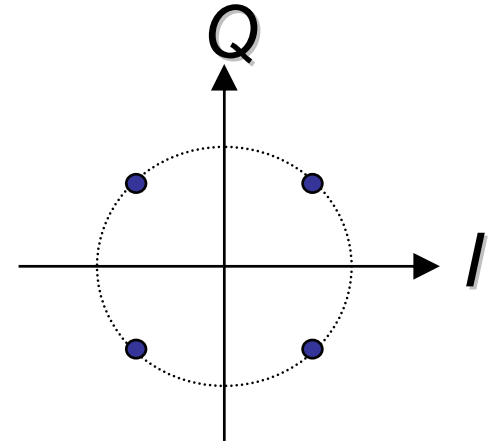

Frequency Division Multiple Access (FDMA)

- Old conventional method (Analog TV, Radio etc.)
- Use separate carrier frequency for individual transmission

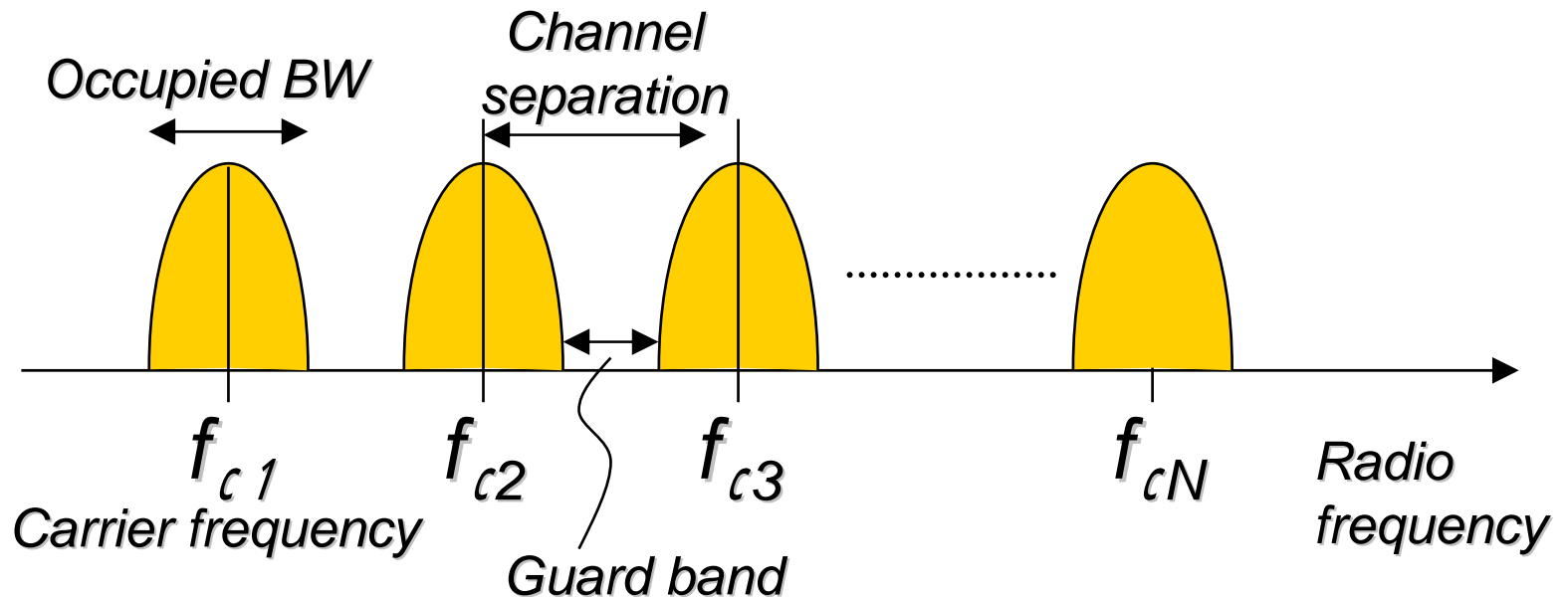

Japan VHF channel assignment

Channel number	Frequency (MHz)
1	90-96
2	96-102
3	102-108
4	170-176
5	176-182
6	182-188
7	188-194
8	192-198
9	198-204
10	204-210
11	210-216
12	216-222

- Channel Separation = 6MHz

Multi-carrier modulation

- Use multiple channel (carrier frequency) for one data transmission

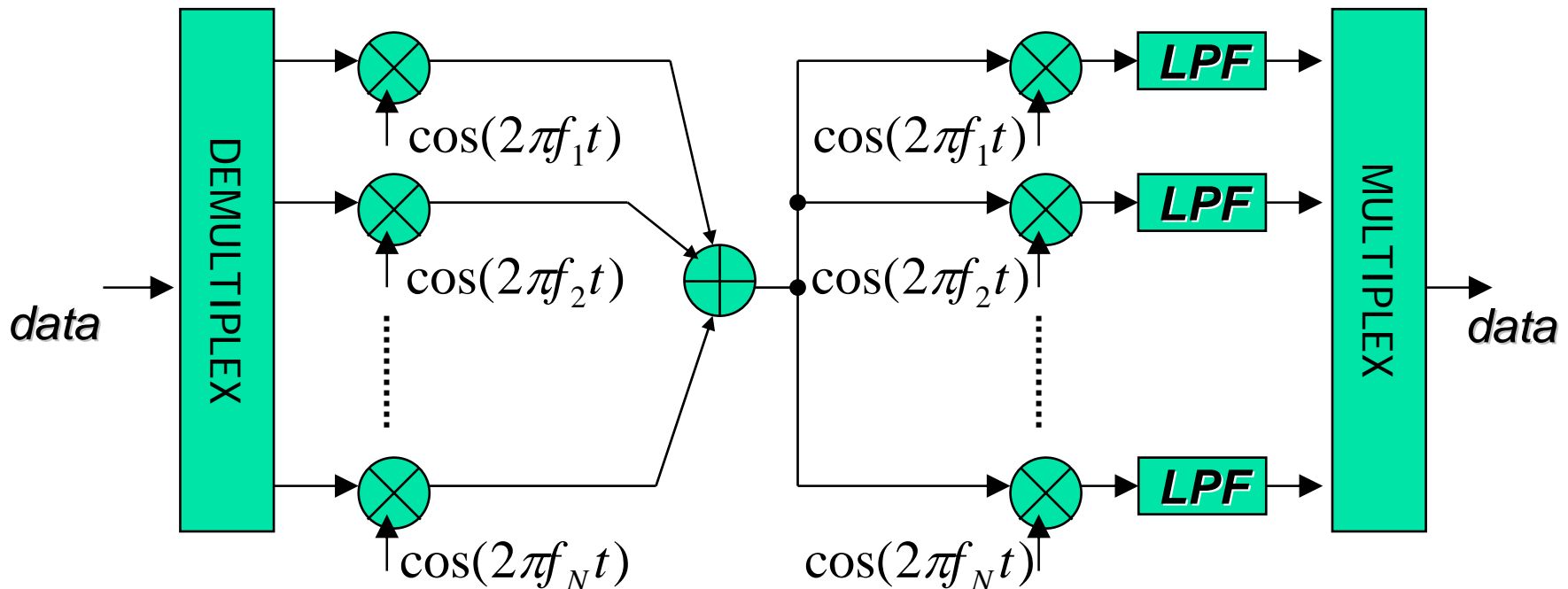

Spectrum comparison for same data rate transmission

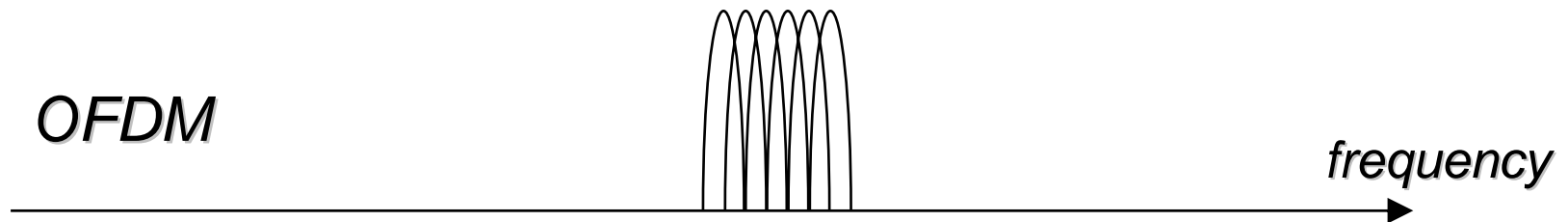
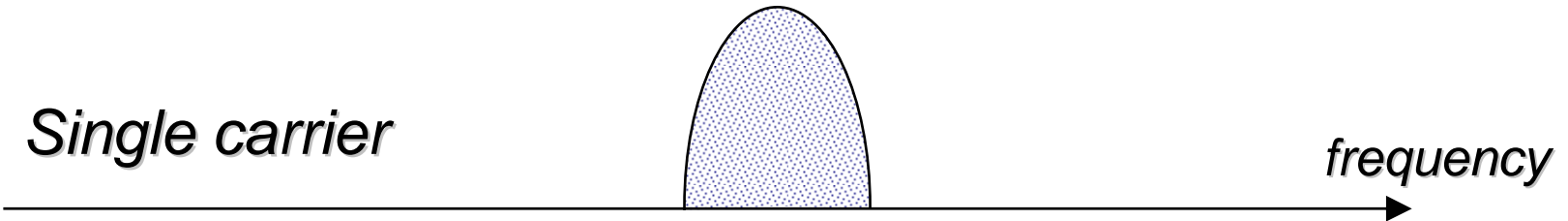
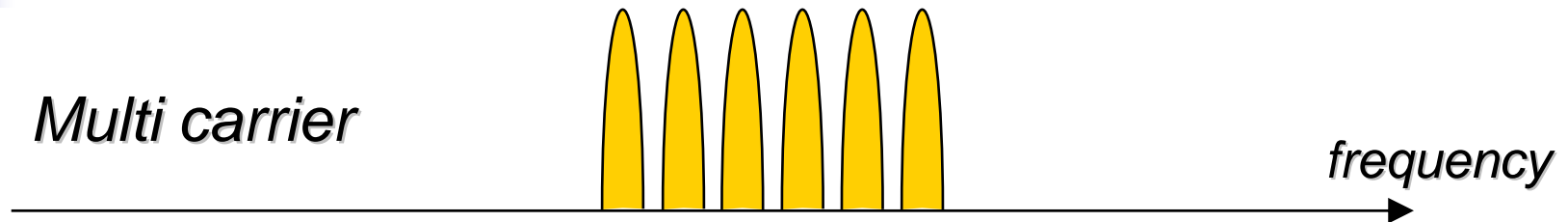



OFDM vs. Multi carrier

- OFDM is multi carrier modulation
- OFDM sub-carrier spectrum is overlapping
- In FDMA, band-pass filter separates each transmission
- In OFDM, each sub-carrier is separated by DFT because carriers are orthogonal
 - Condition of the orthogonality will be explained later
- Each sub-carrier is modulated by PSK, QAM

Thousands of PSK/QAM symbol can be simultaneously transmitted in one OFDM symbol

OFDM carriers

- OFDM carrier frequency is $n \cdot 1/T$

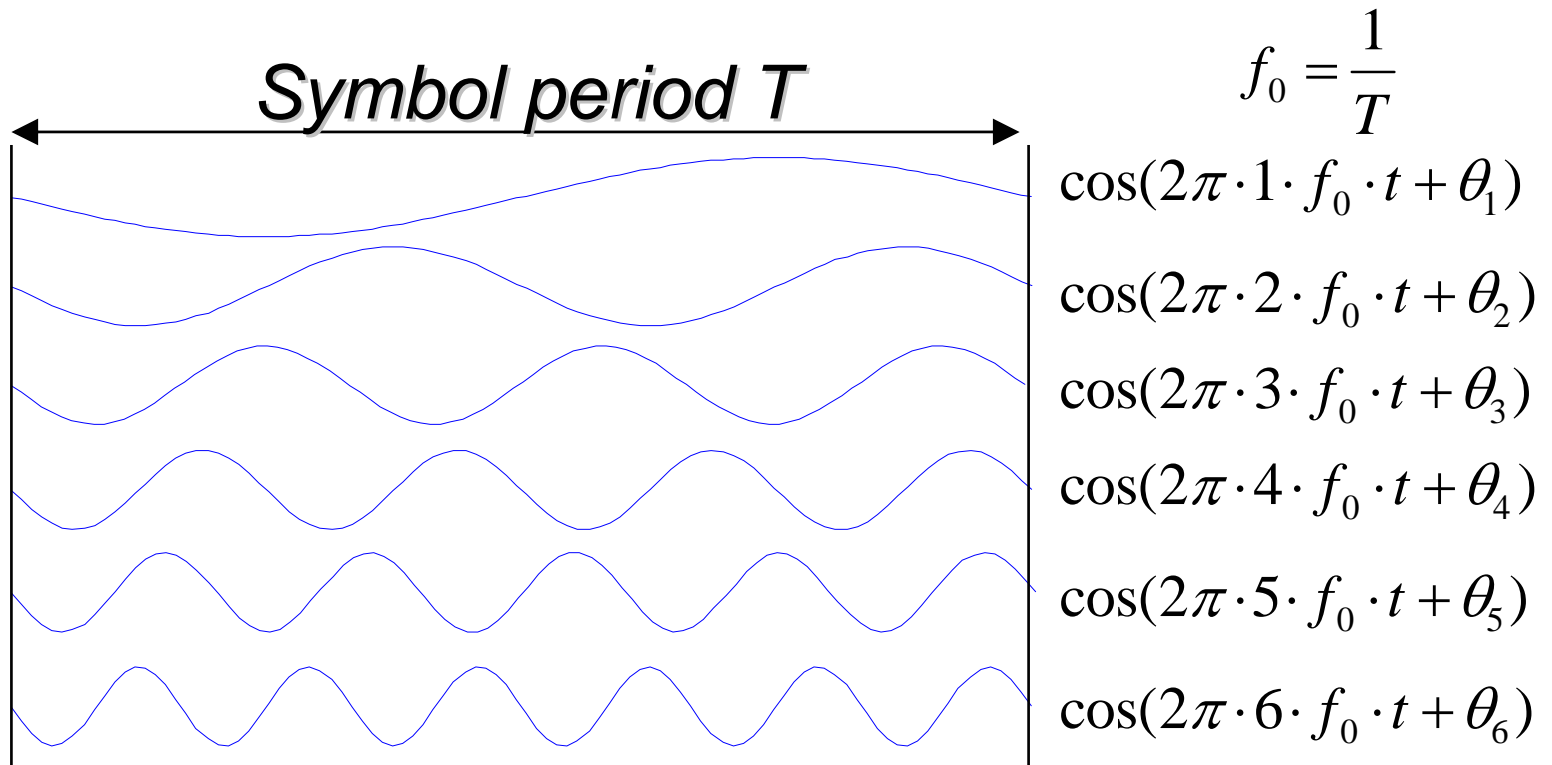



Sinusoidal Orthogonality

- m, n : integer, $T = 1/f_0$

$$\int_0^T \cos(2\pi m f_0 t) \cdot \cos(2\pi n f_0 t) dt = \begin{cases} \frac{T}{2} & (m = n) \\ 0 & (m \neq n) \end{cases} \longrightarrow \text{Orthogonal}$$

$$\int_0^T \sin(2\pi m f_0 t) \cdot \sin(2\pi n f_0 t) dt = \begin{cases} \frac{T}{2} & (m = n) \\ 0 & (m \neq n) \end{cases} \longrightarrow \text{Orthogonal}$$

$$\int_0^T \cos(2\pi m f_0 t) \cdot \sin(2\pi n f_0 t) dt = 0 \longrightarrow \text{Orthogonal}$$

A sub-carrier of $f = nf_0$

$$a_n \cdot \cos(2\pi n f_0 t) - b_n \cdot \sin(2\pi n f_0 t)$$

$$= \sqrt{a_n^2 + b_n^2} \cos(2\pi n f_0 t + \phi_n), \quad \phi_n = \tan^{-1} \frac{b_n}{a_n}$$

- Amplitude and Phase will be digitally modulated

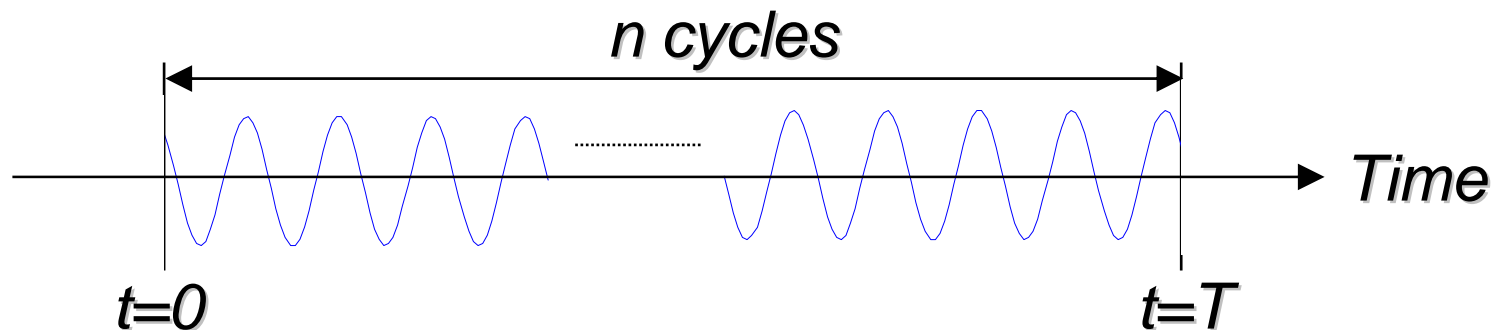

Base-band OFDM signal

$$s_B(t) = \sum_{n=0}^{N-1} \{a_n \cos(2\pi n f_0 t) - b_n \sin(2\pi n f_0 t)\}$$

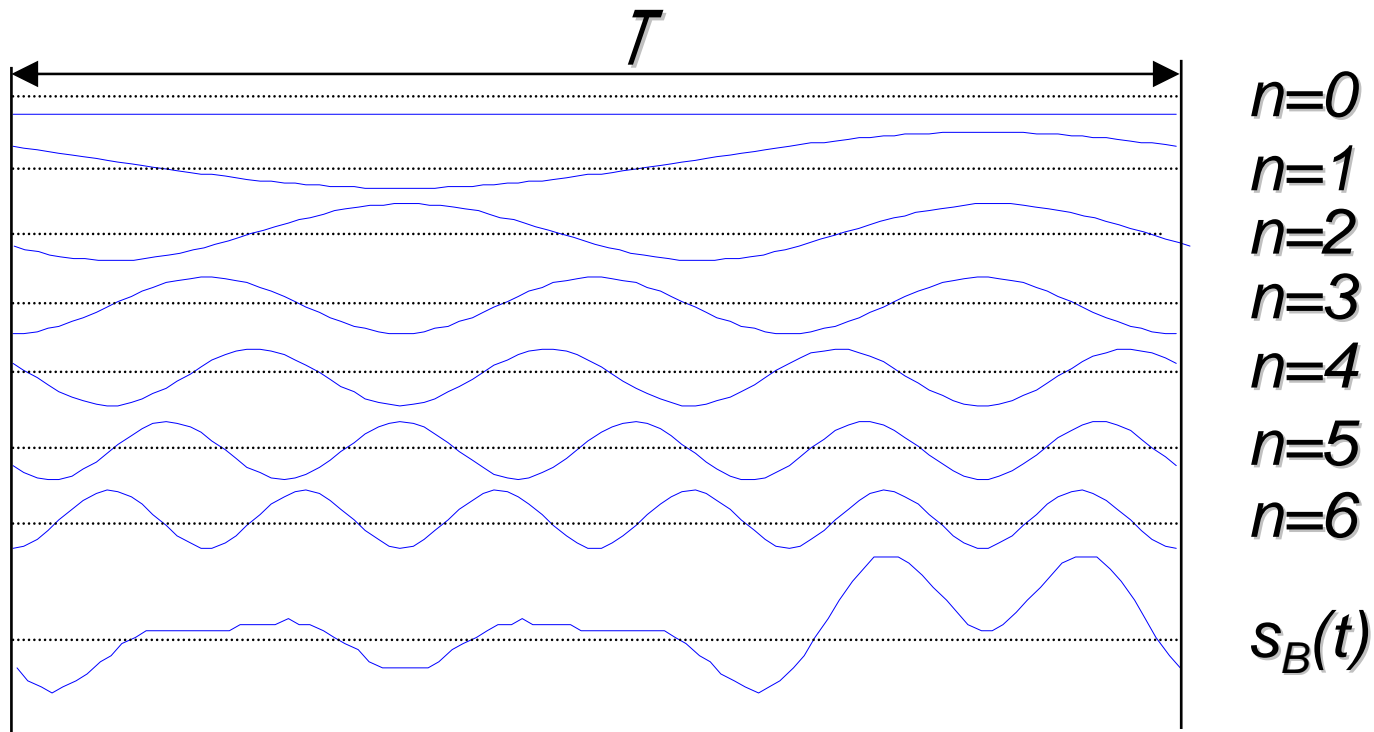

How a_n, b_n are calculated from $s_B(t)$

- Demodulation Procedure -

$$\begin{aligned} & \int_0^T s_B(t) \cdot \cos(2\pi k f_0 t) dt \\ &= \sum_{n=0}^{N-1} \left\{ a_n \int_0^T \cos(2\pi n f_0 t) \cos(2\pi k f_0 t) dt - b_n \int_0^T \sin(2\pi n f_0 t) \cos(2\pi k f_0 t) dt \right\} \\ &= \frac{T}{2} a_k \end{aligned}$$

$$\int_0^T s_B(t) \{-\sin(2\pi k f_0 t)\} dt = \frac{T}{2} b_k$$

- According to the sinusoidal orthogonality, a_n, b_n can be extracted.
- In actual implementation, DFT(FFT) is used
- N is roughly 64 for WLAN, thousand for Terrestrial Video Broadcasting



Pass-band OFDM signal

- $S_B(t)$ is upconverted to pass-band signal $S(t)$
- f_c frequency shift

$$s(t) = \sum_{n=0}^{N-1} \left[a_n \cos\{2\pi(f_c + nf_0)t\} - b_n \sin\{2\pi(f_c + nf_0)t\} \right]$$

Actual OFDM spectrum

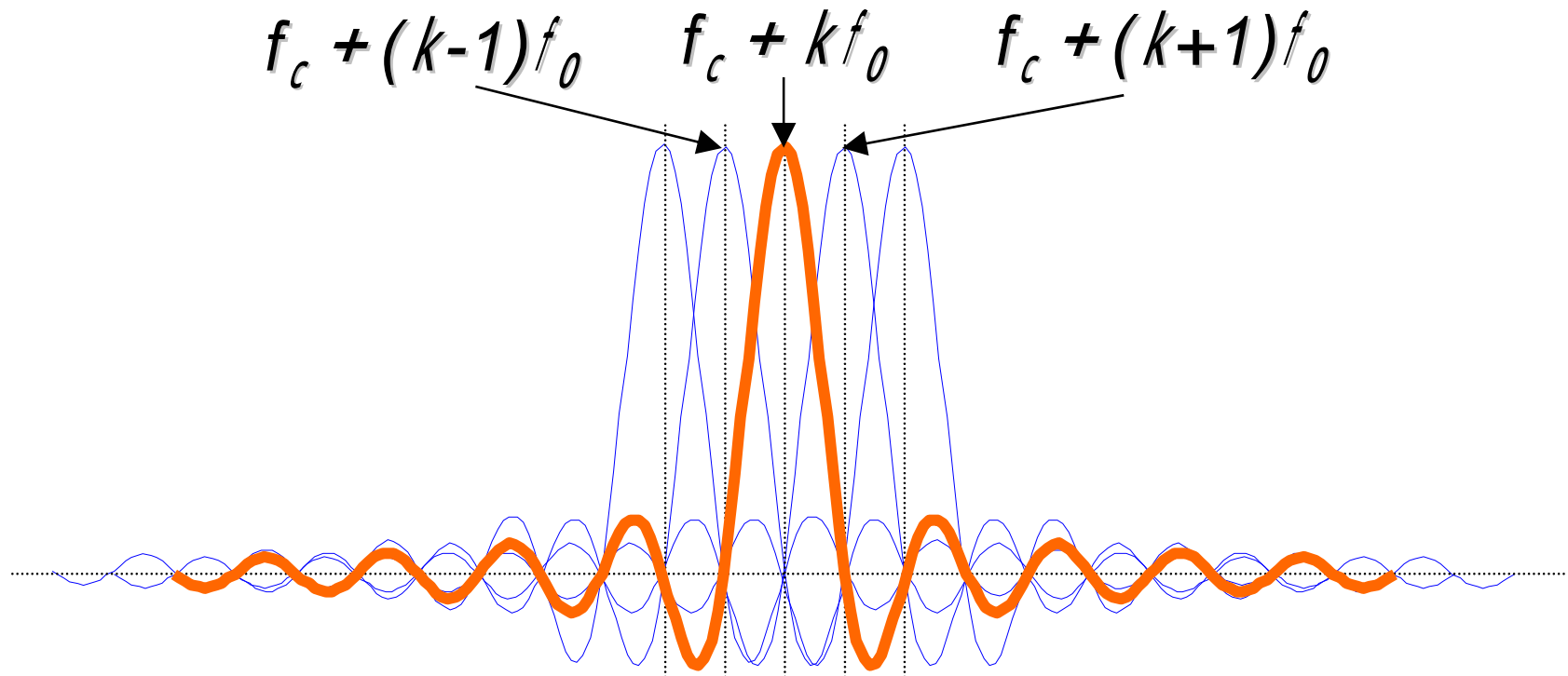

OFDM power spectrum

- Total Power spectrum is almost square shape

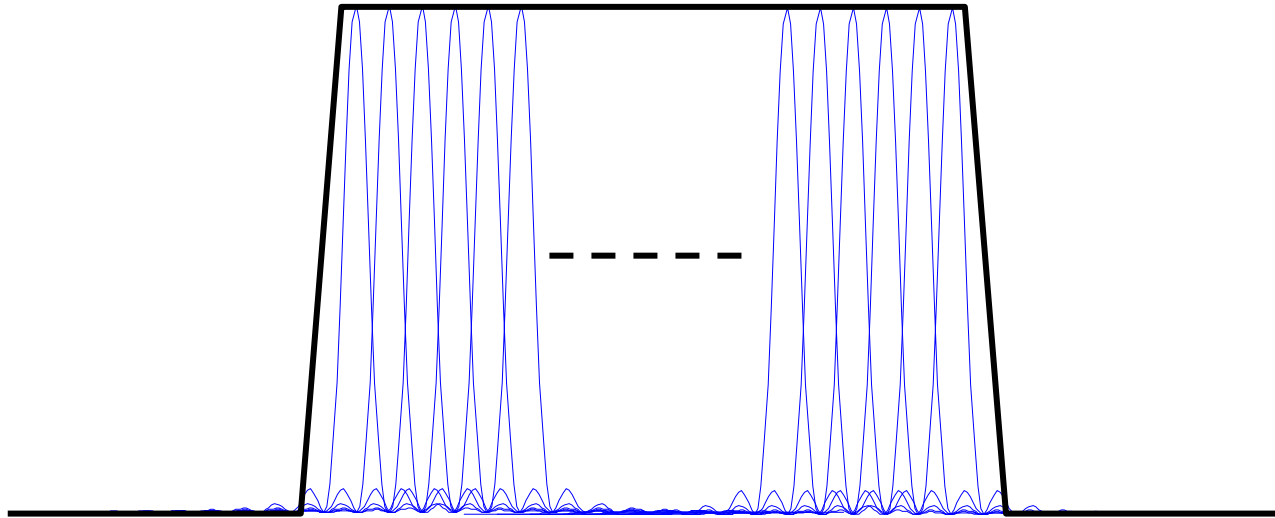



OFDM signal generation

$$s(t) = \sum_{n=0}^{N-1} \left[a_n \cos\{2\pi(f_c + nf_0)t\} - b_n \sin\{2\pi(f_c + nf_0)t\} \right]$$

- Direct method needs
 - N digital modulators
 - N carrier frequency generator
 - ➔ Not practical
- In 1971, method using DFT is proposed to OFDM signal generation

OFDM signal generation in digital domain

- Define complex base-band signal $u(t)$ as follows

$$s_B(t) = \text{Re}[u(t)]$$

$$u(t) = \sum_{n=0}^{N-1} d_n \cdot e^{j2\pi n f_0 t}, \quad d_n = a_n + j b_n$$

- Perform N times sampling in period T

$$\begin{aligned} u\left(\frac{k}{Nf_0}\right) &= \sum_{n=0}^{N-1} d_n \cdot e^{j2\pi n f_0 \frac{k}{Nf_0}} = \sum_{n=0}^{N-1} d_n \cdot e^{j\frac{2\pi n k}{N}} \\ &= \sum_{n=0}^{N-1} d_n \cdot \left(e^{j\frac{2\pi}{N}} \right)^{nk} \quad (k = 0, 1, 2, \dots, N-1) \end{aligned}$$

$$u(k) = \text{IFFT}(d_n) = \text{IFFT}(a_n + j b_n)$$

OFDM modulator

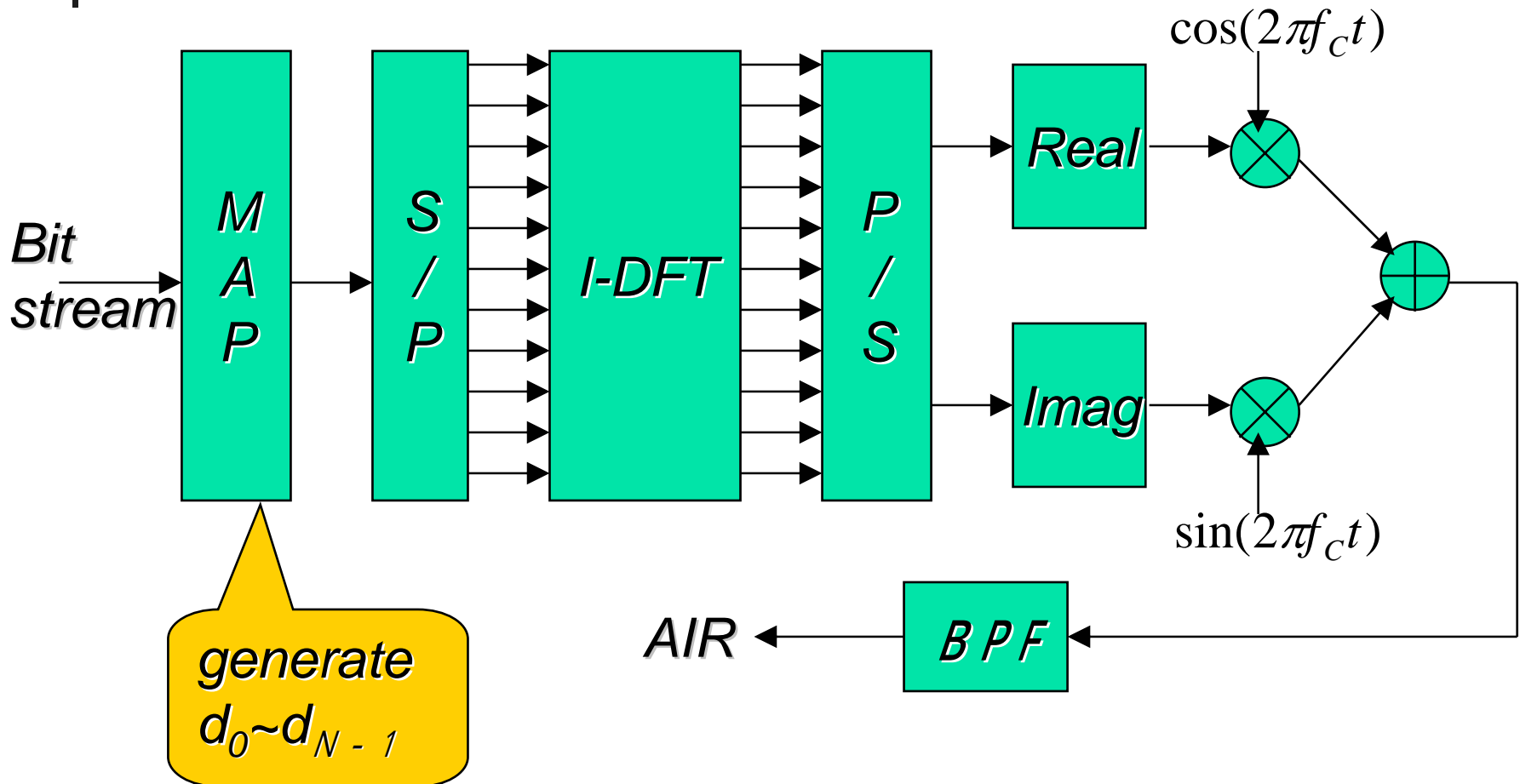



OFDM demodulation

$$s(t) = \sum_{n=0}^{N-1} [a_n \cos \{2\pi (f_c + nf_0)t\} - b_n \sin \{2\pi (f_c + nf_0)t\}]$$

$$LPF [s(t) \cdot \cos(2\pi f_c t)] = \frac{1}{2} \sum_{n=0}^{N-1} \{a_n \cos(2\pi n f_0 t) - b_n \sin(2\pi n f_0 t)\} = \frac{1}{2} s_I(t)$$

$$LPF [s(t) \cdot \{-\sin(2\pi f_c t)\}] = \frac{1}{2} \sum_{n=0}^{N-1} \{a_n \sin(2\pi n f_0 t) + b_n \cos(2\pi n f_0 t)\} = \frac{1}{2} s_Q(t)$$

$$u(t) = s_I(t) + js_Q(t) = \sum_{n=0}^{N-1} d_n \cdot e^{j2\pi n f_0 t}$$

$$d_n = FFT(u(k))$$

OFDM demodulator (Too simple)

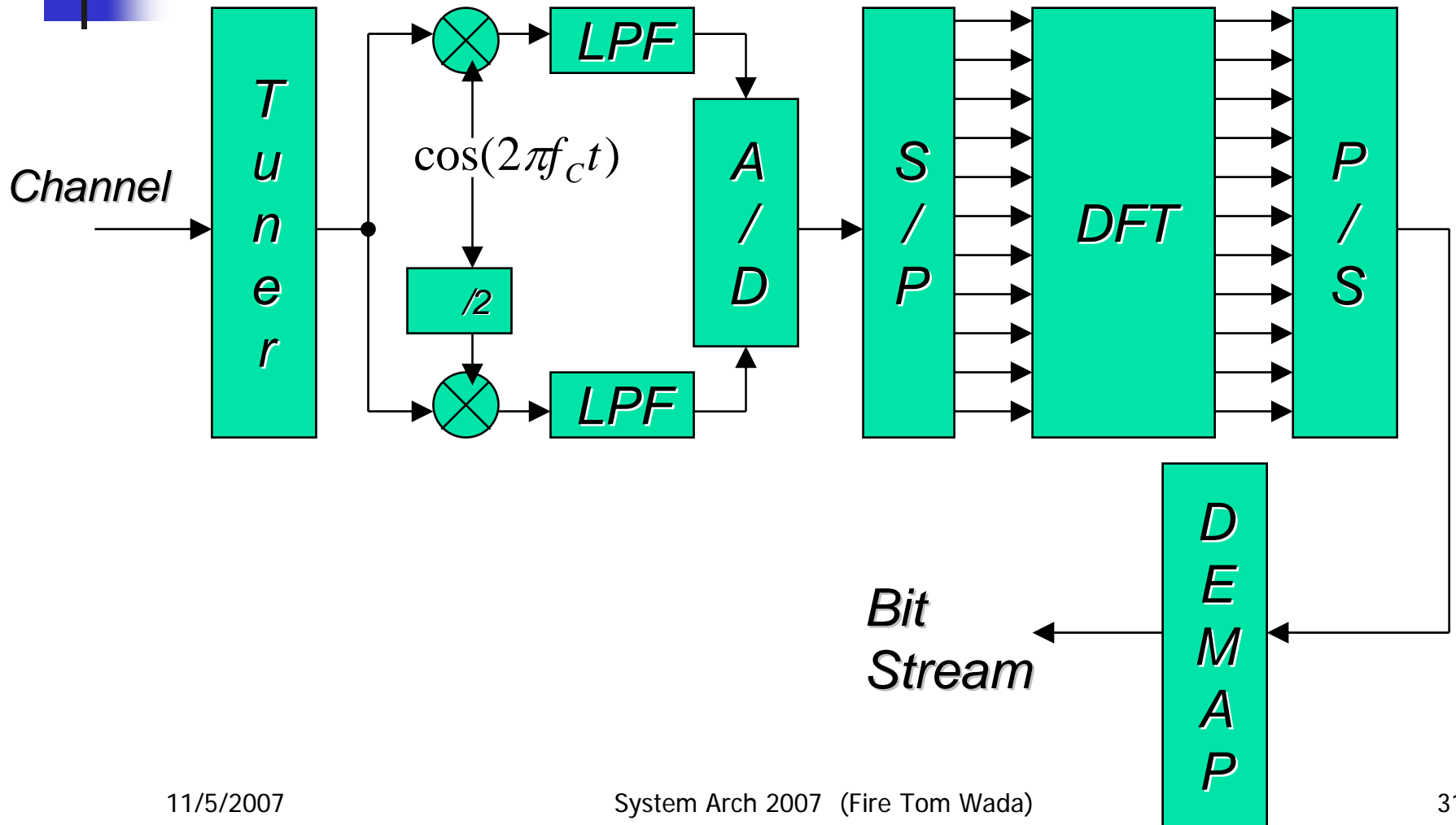

Summary of OFDM signal

- Each symbol carries information
- Each symbol wave is sum of many sinusoidal
- Each sinusoidal wave can be PSK, QAM modulated
- Using IDFT and DFT, OFDM implementation became practical

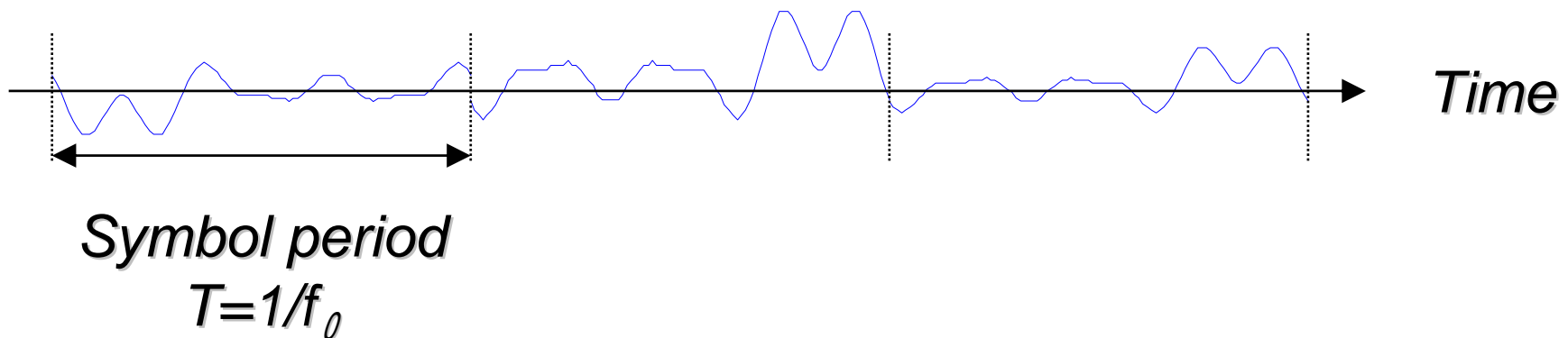

Multi-path

- Delayed wave causes interference

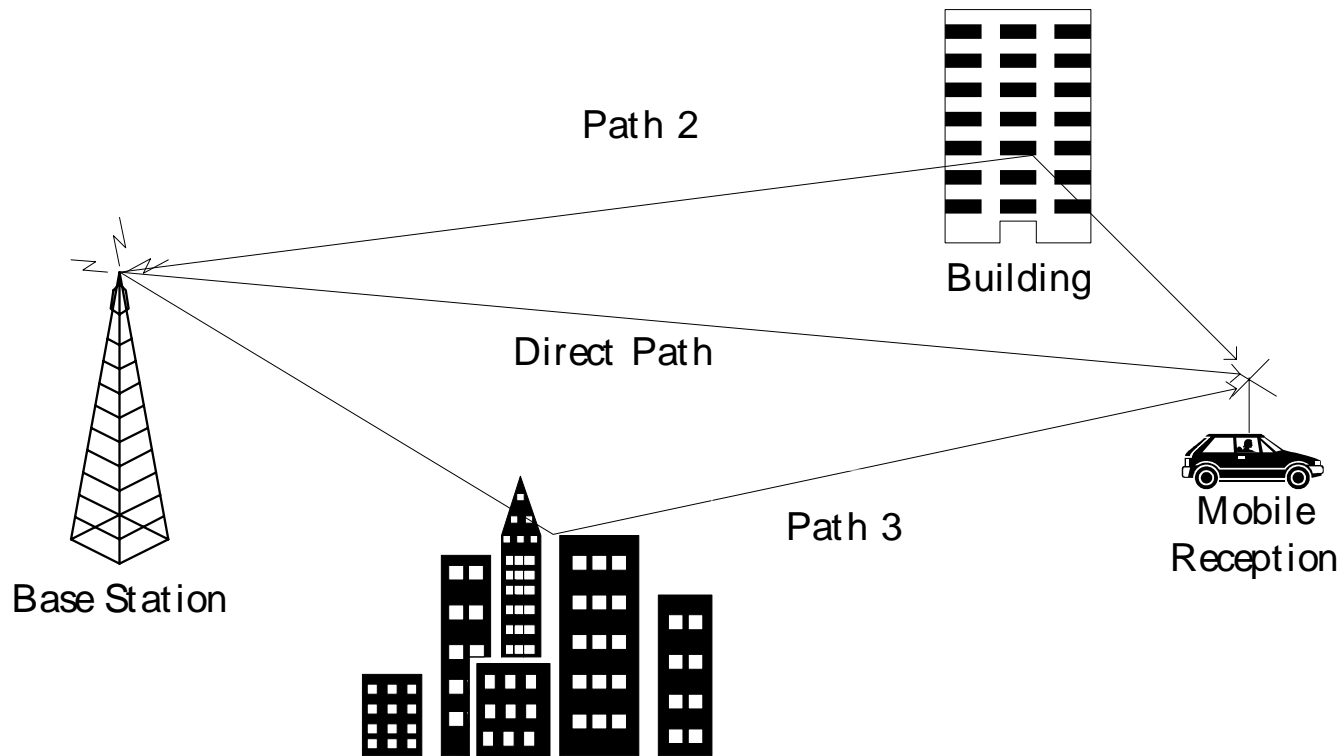

Multi-pass effect

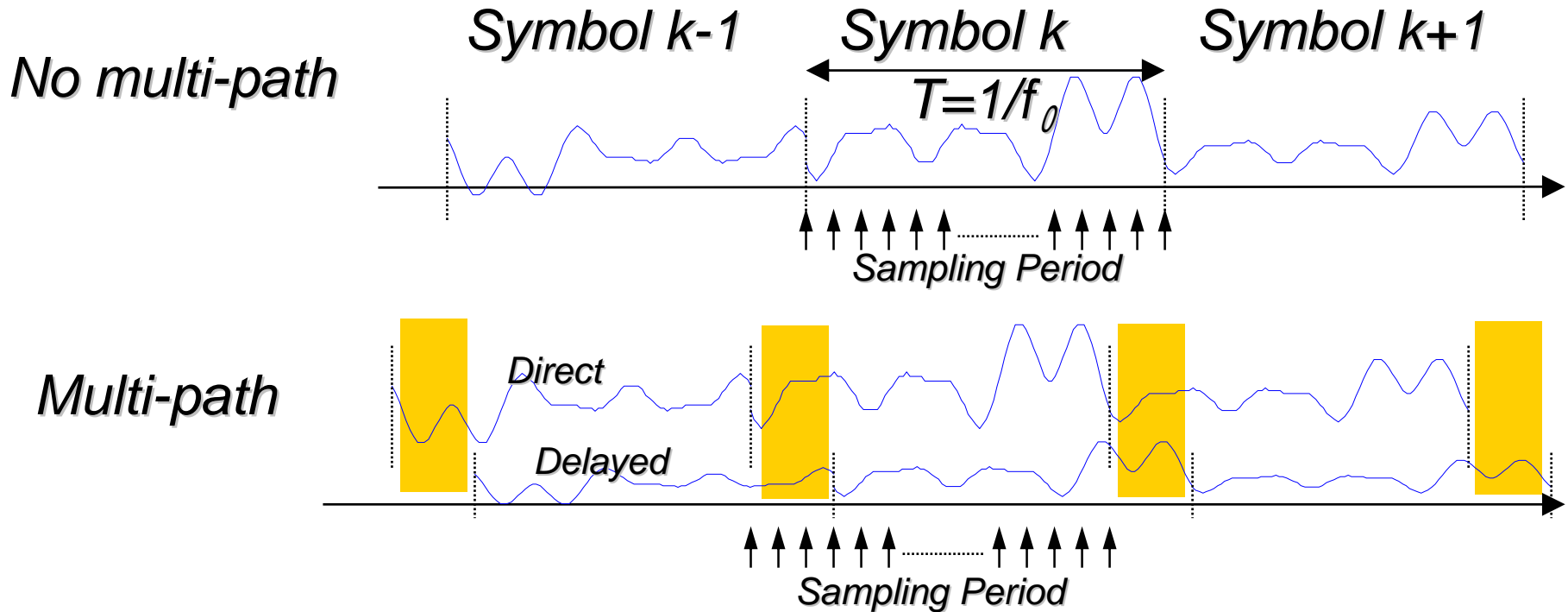

- Inter symbol interference (ISI) happens in Multi-path condition

Guard Interval T_g

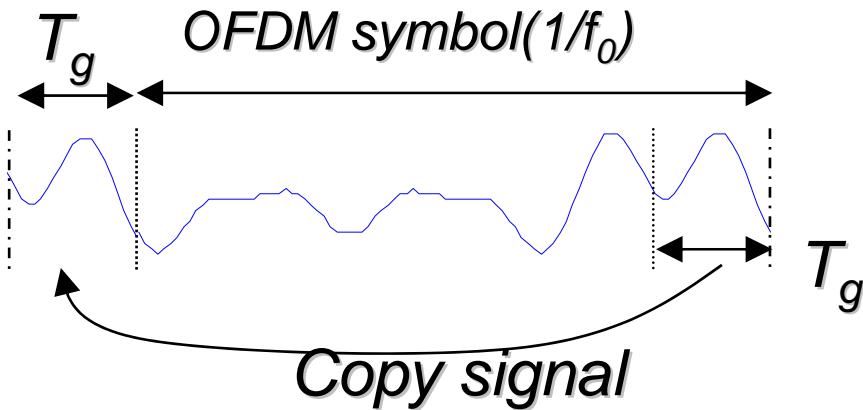

- By adding the Guard Interval Period, ISI can be avoided

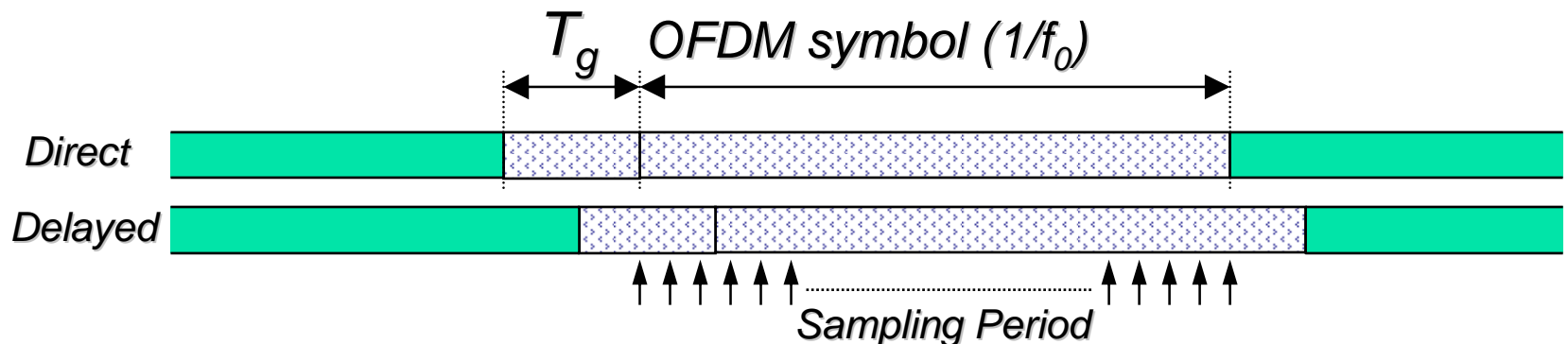

Multi-path

- By adding GI, orthogonality can be maintained
- However, multi-path causes Amplitude and Phase distortion for each sub-carrier
- The distortion has to be compensated by Equalizer

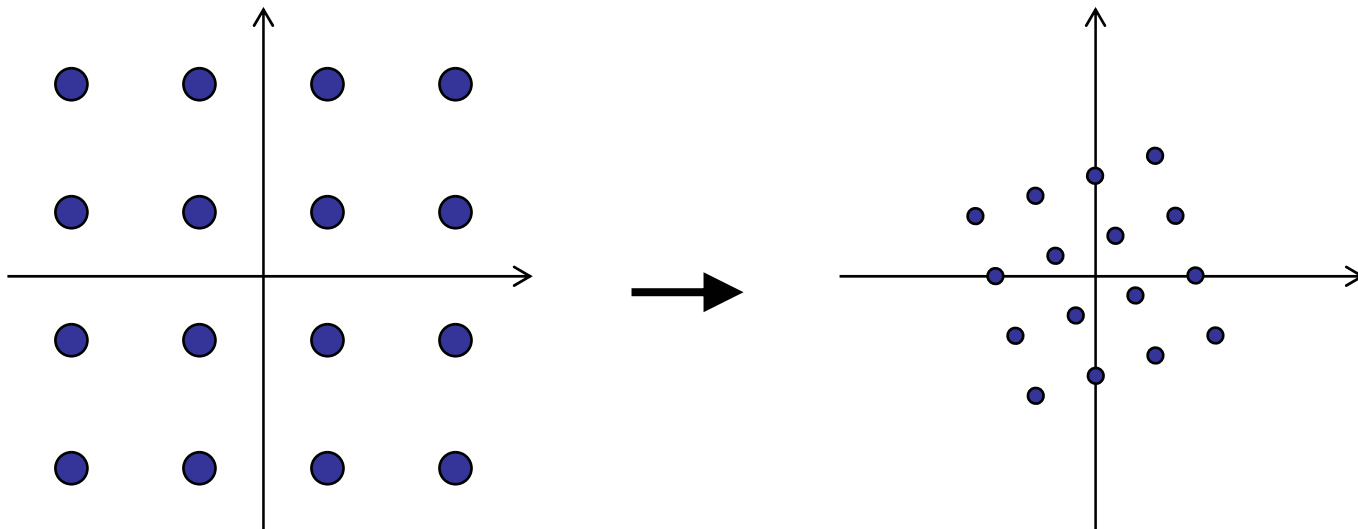

Multiple Frequency Network

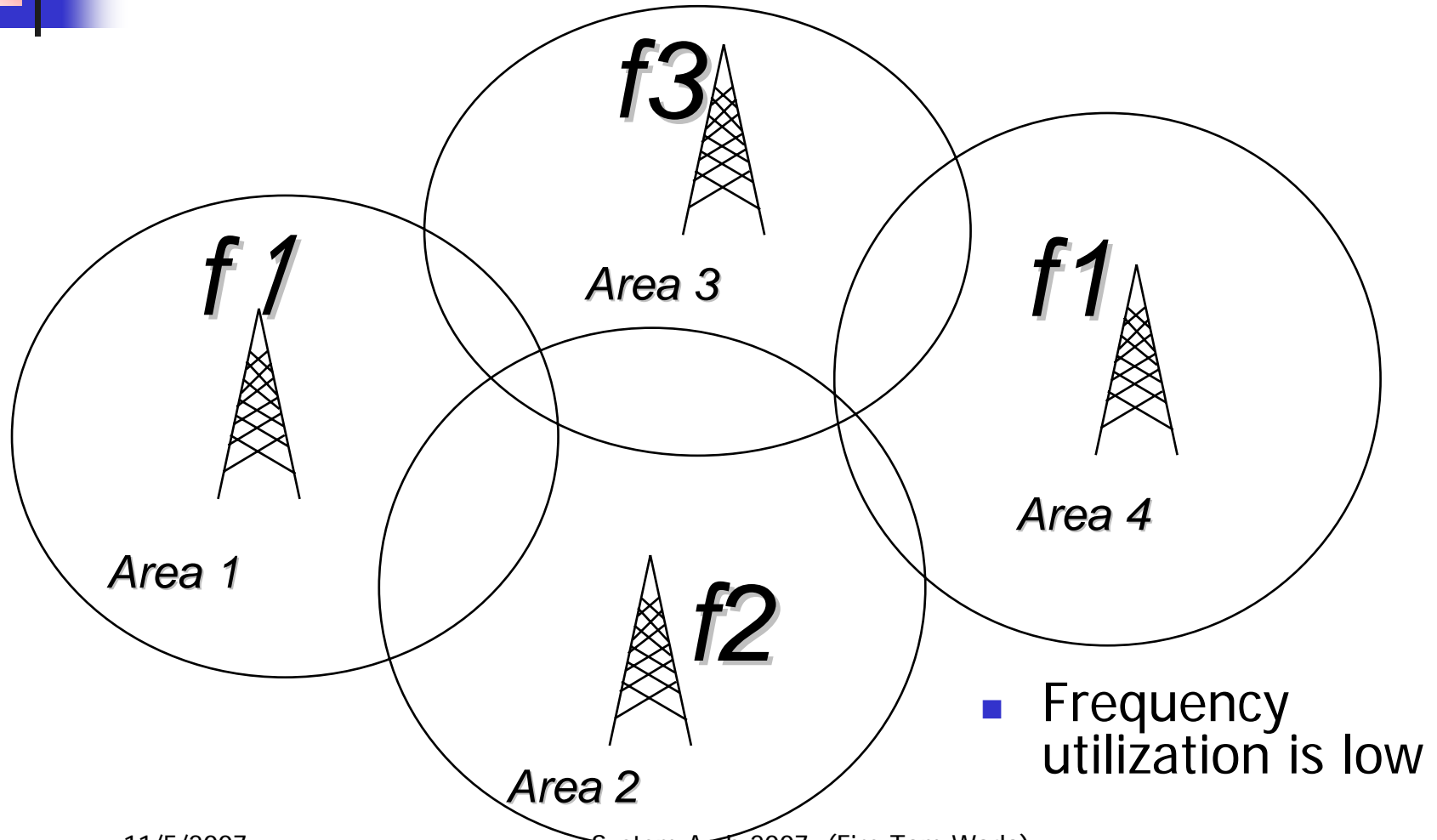

Single Frequency Network

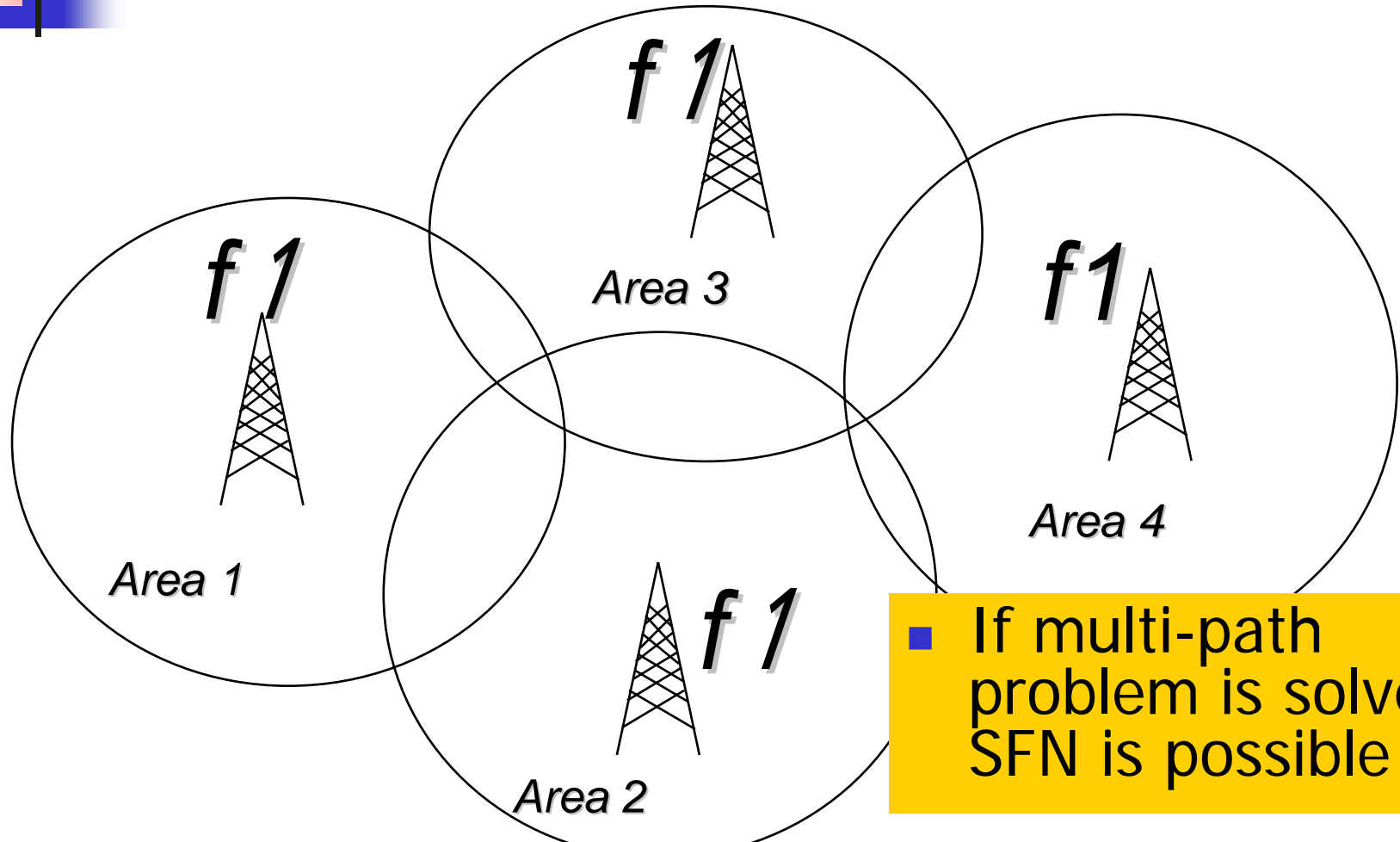

- If multi-path problem is solved, SFN is possible



That's all for introduction

- Feature of OFDM
 1. High Frequency utilization by the square spectrum shape
 2. Multi-path problem is solved by GI
 3. Multiple services in one OFDM by sharing sub-carriers (3 services in ISDB-T)
 4. SFN
 5. Implementation was complicated but NOW possible because of LSI technology progress