



SEMICONDUCTOR TECHNOLOGY -CMOS-

Fire Tom Wada

What is semiconductor and LSIs

- Huge number of transistors can be integrated in a small Si chip.
- The size of the chip is roughly the size of nails.
- Currently, 1000M transistors can be integrated.
- 1000 times integration comparing to 20 yrs ago.
- The cost of the chip is roughly same.
- All electronic equipments are powered by LSIs.
- PCs, Cellular phones, 3D graphics, Internet.

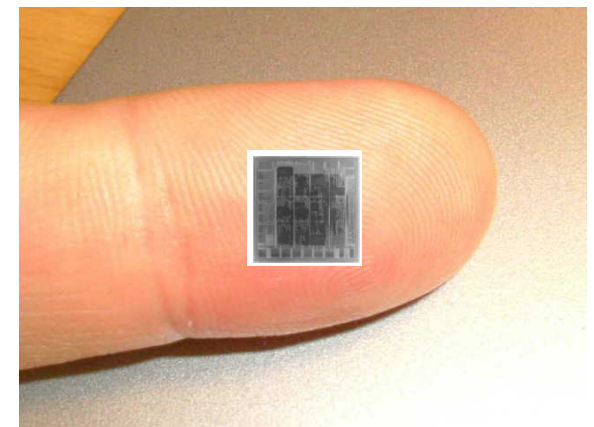

PC mother board

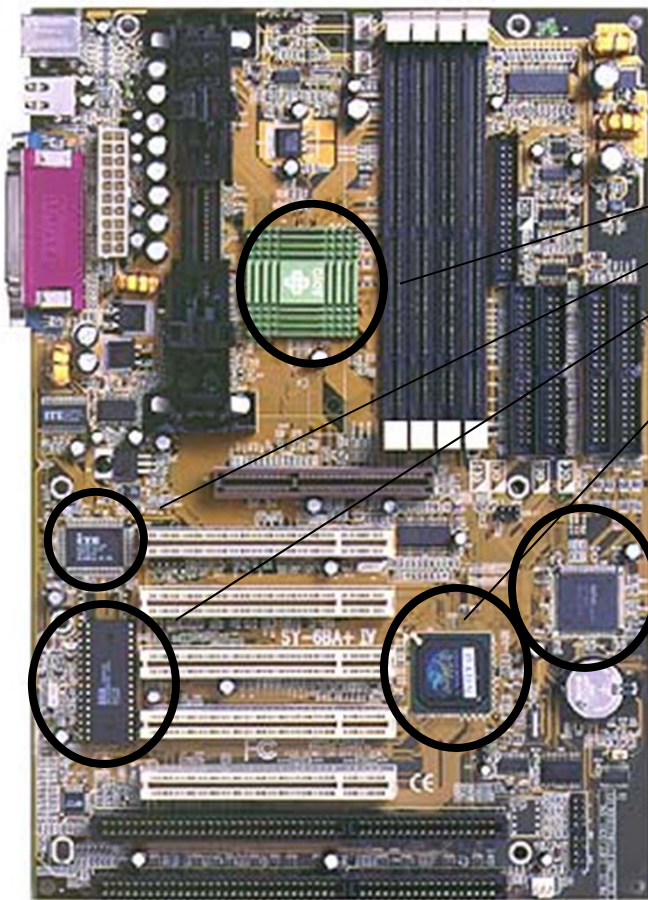

**Large Scale
Integration**

SONY PLAYSTATION 2 MAINBOARD

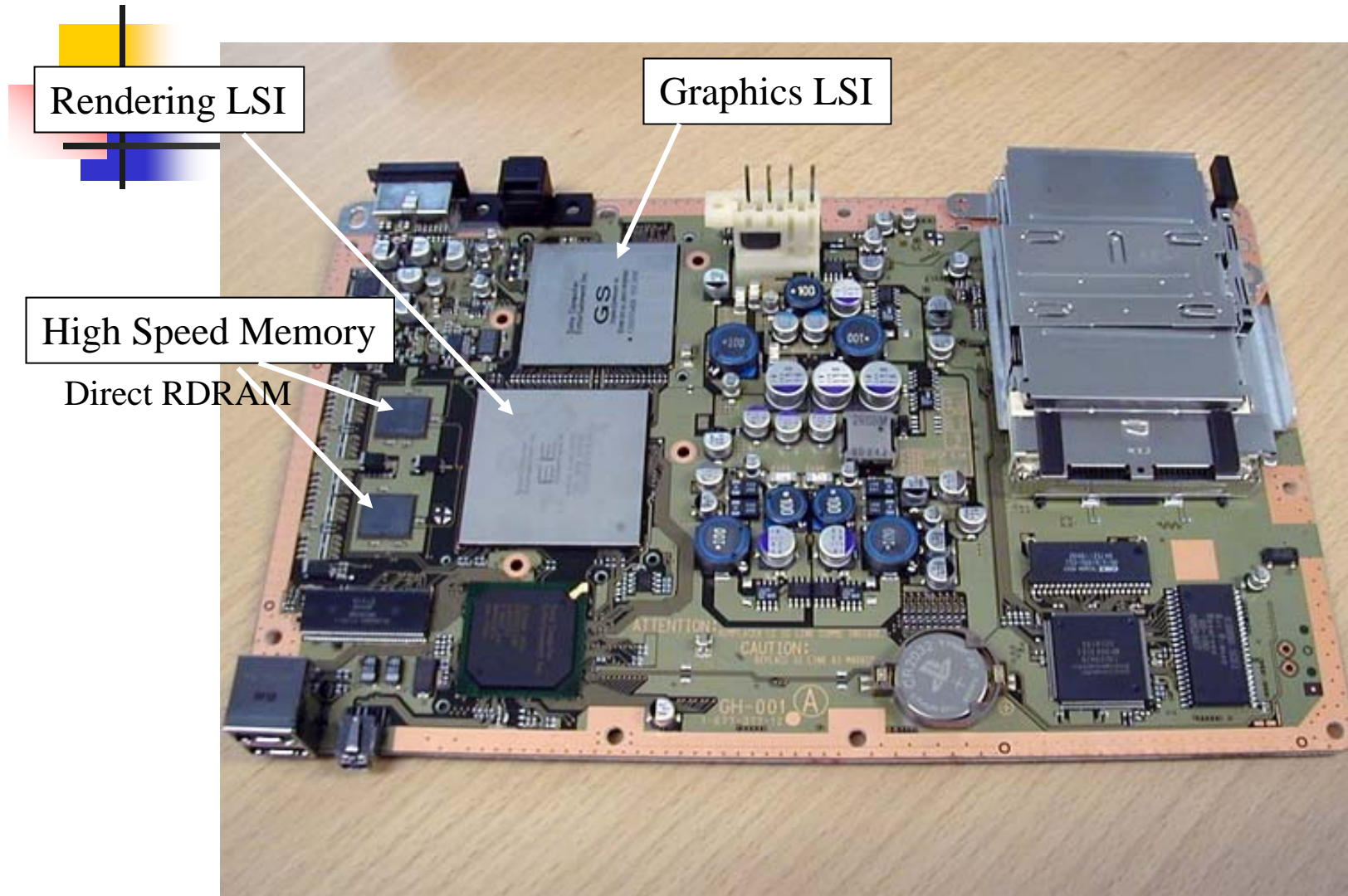

Mobile Phone Mainboard

Memory, Logic, Analog

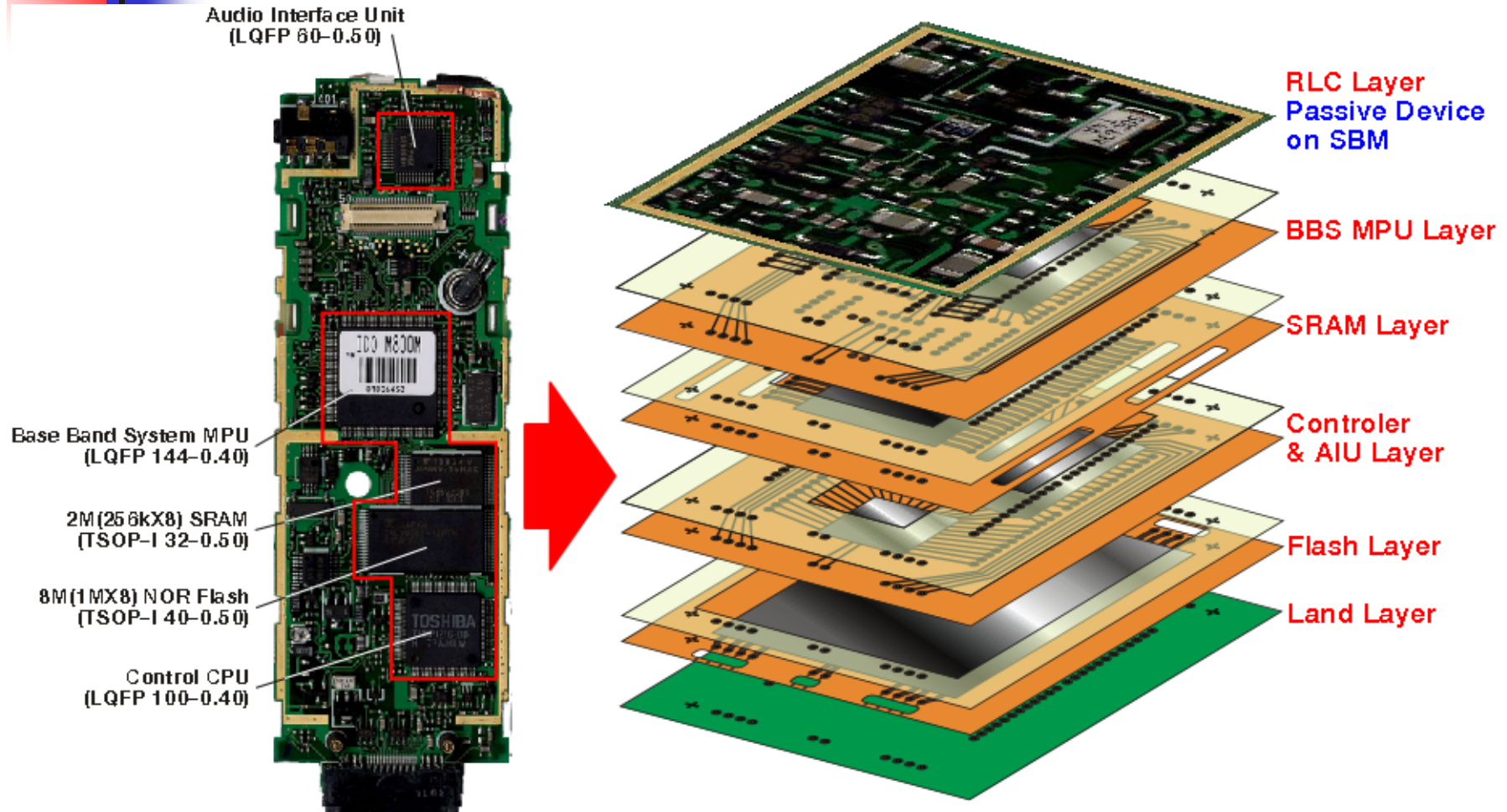

Key device is LSI

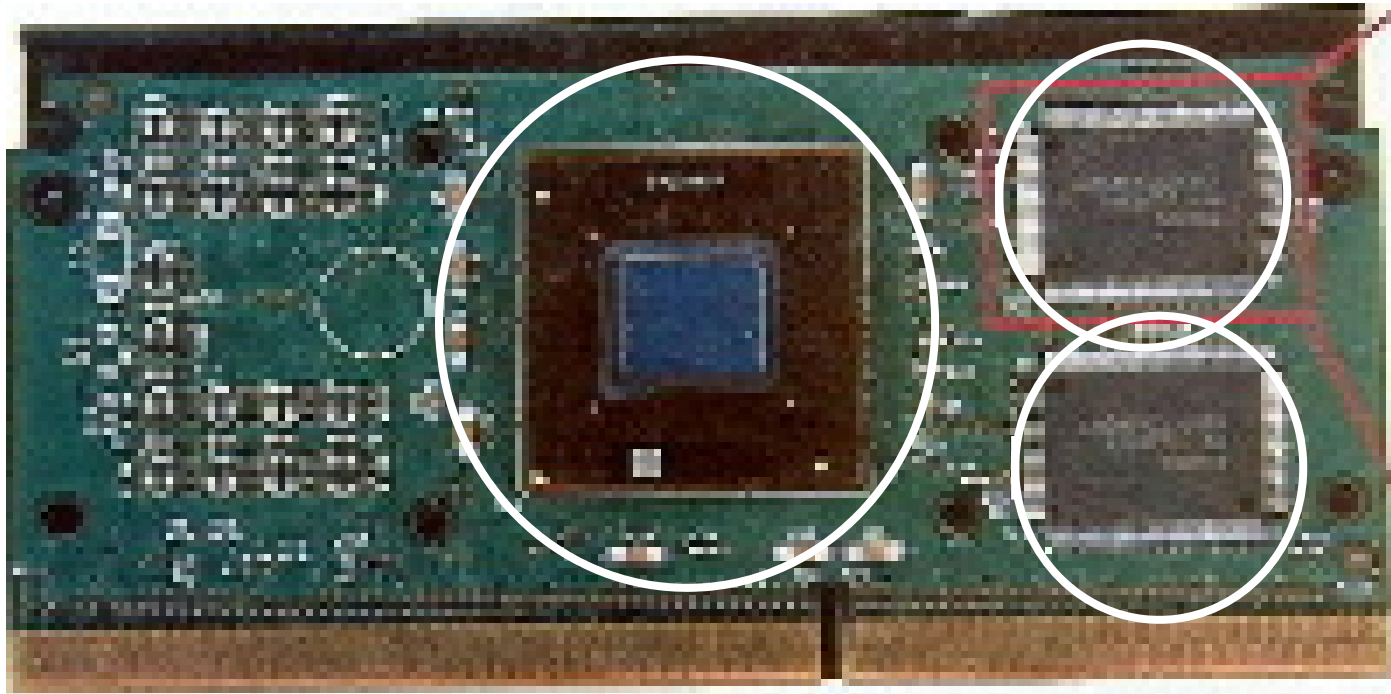

INTEL Pentium III module

This is a packaged LSI -Pentium III 300MHz Cache LSI-

15 mm

20 mm

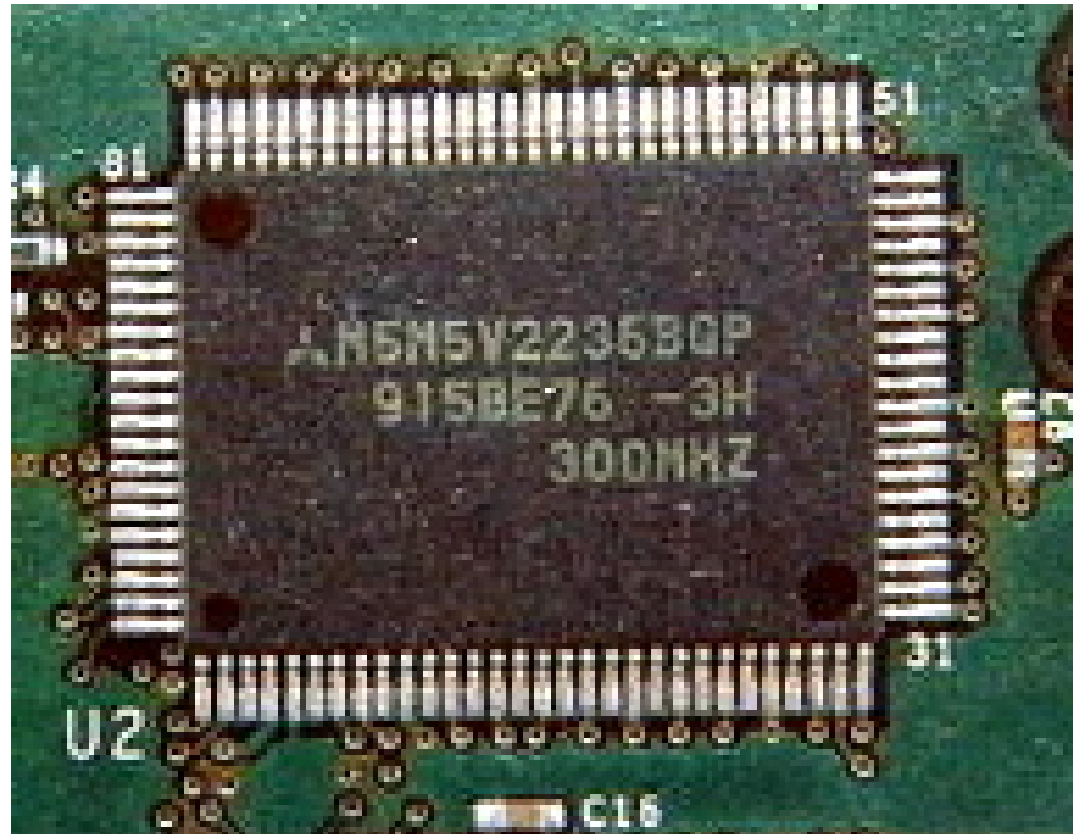



Si chip is molded in the package.

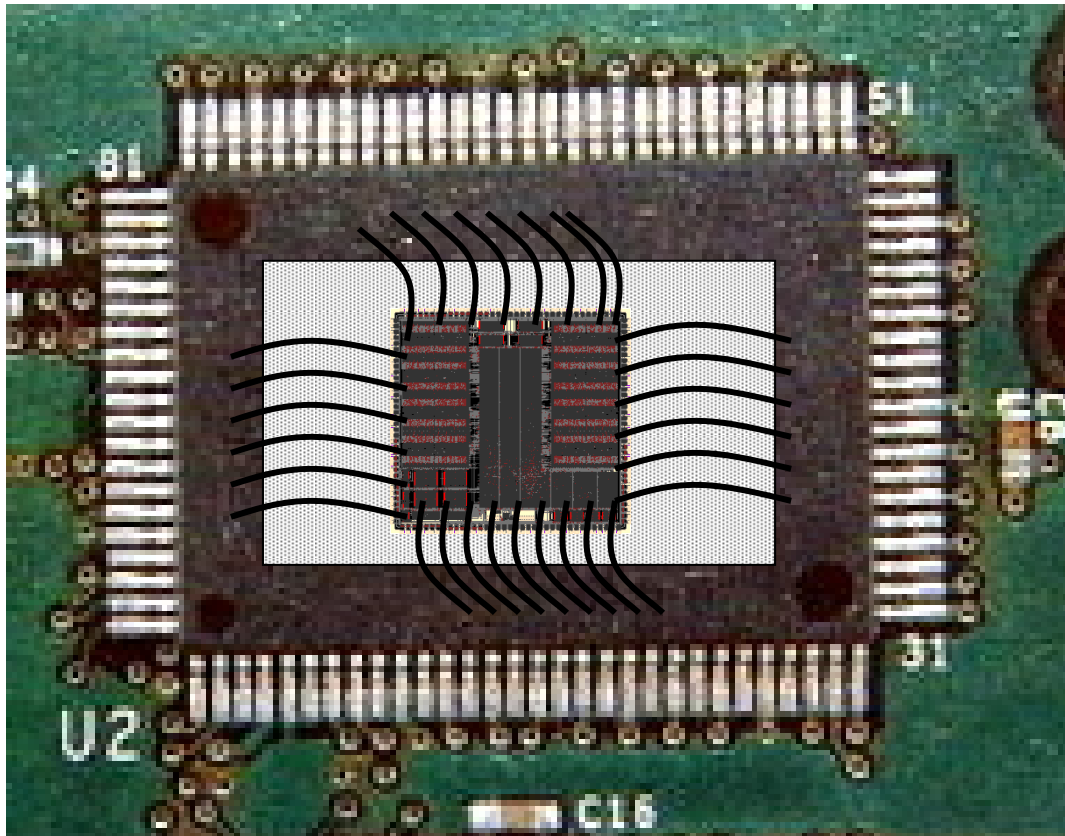

2 million transistor
Chip is connected
to the pins thru
wires.

6 inches Si wafer

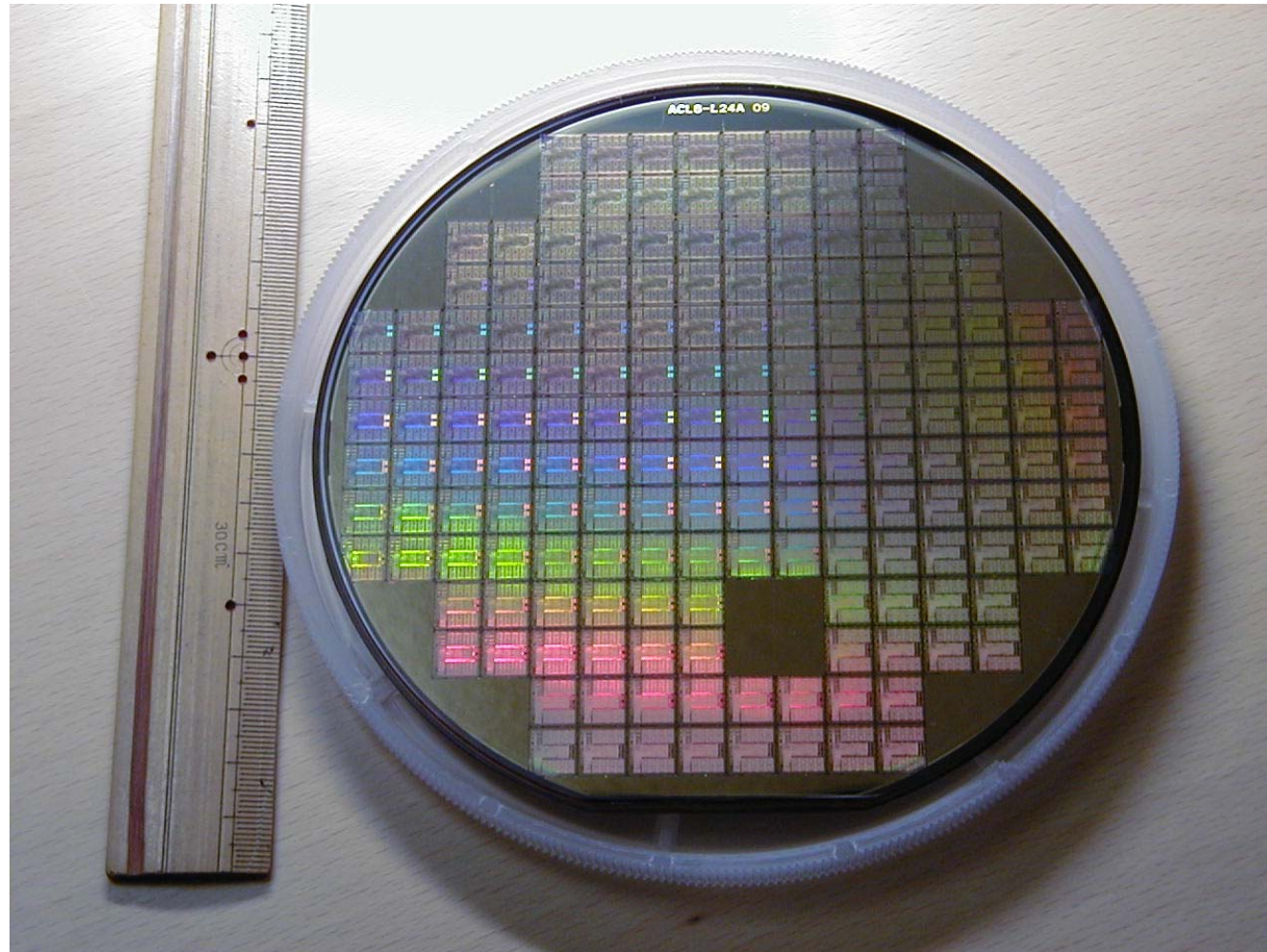

8 inches Si wafer

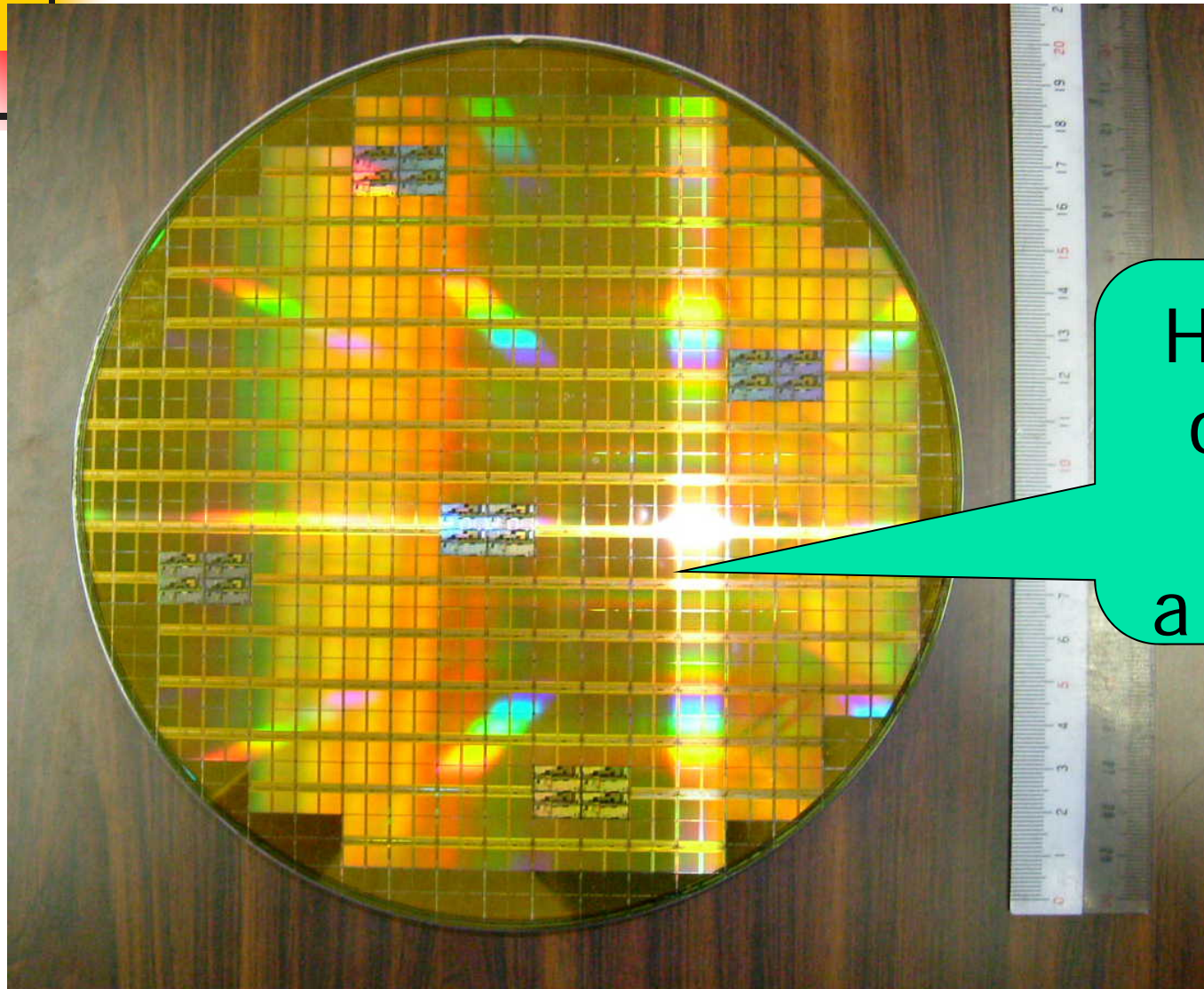

Hundreds
of Chips
on
a Si Wafer

Several hundreds of chips are fabricated on a wafer simultaneously.

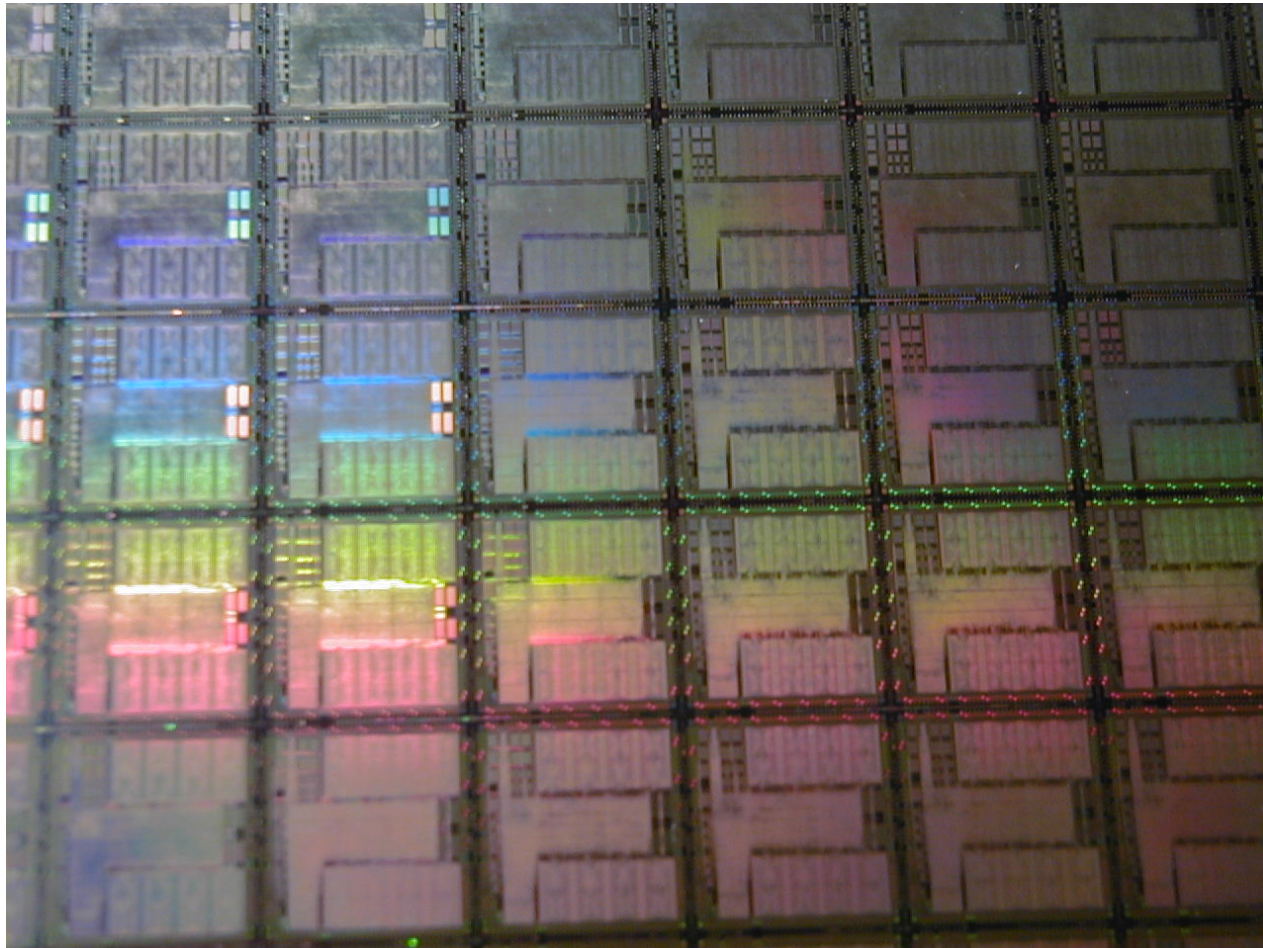

Chip photo

- Motion Estimation Chip for HDTV camera -

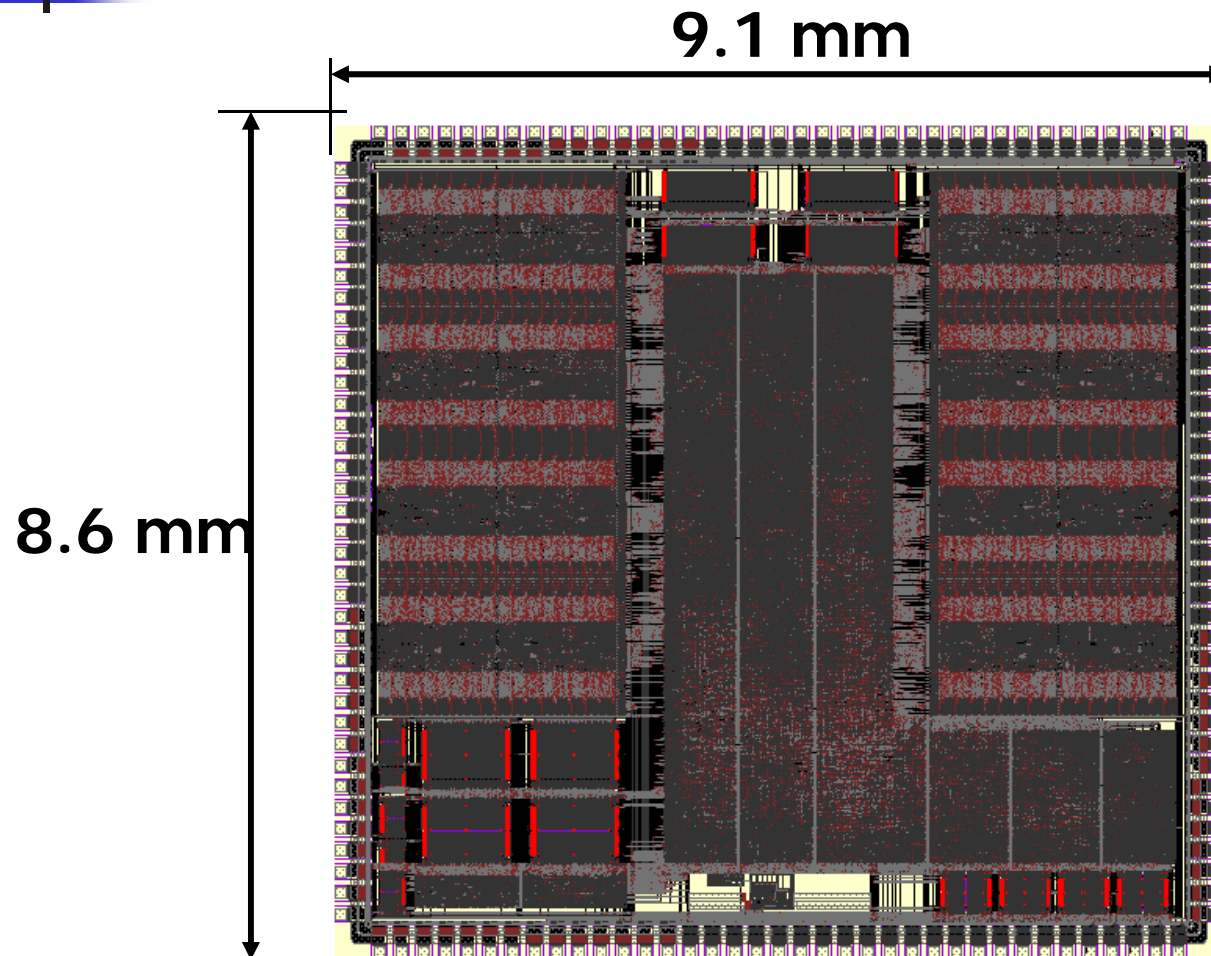

**Your small
finger's
nail size.
200M
transistors.**

Scanning Electron Microscope photo - Cross-section of the LSI -



0.5μm



0.5 micron



Structure Of CMOS LSI

- Isolation
 - PN-Isolation, Local oxidation
- Si Substrate
 - Bulk, epitaxial , SOI
- Well Structure
 - N-type well in P-type Substrate
- Latch Up
 - PNP Bipolar Transistor and NPN Bipolar Transistor
- Fabrication Process Technology

Cross-section of the LSI

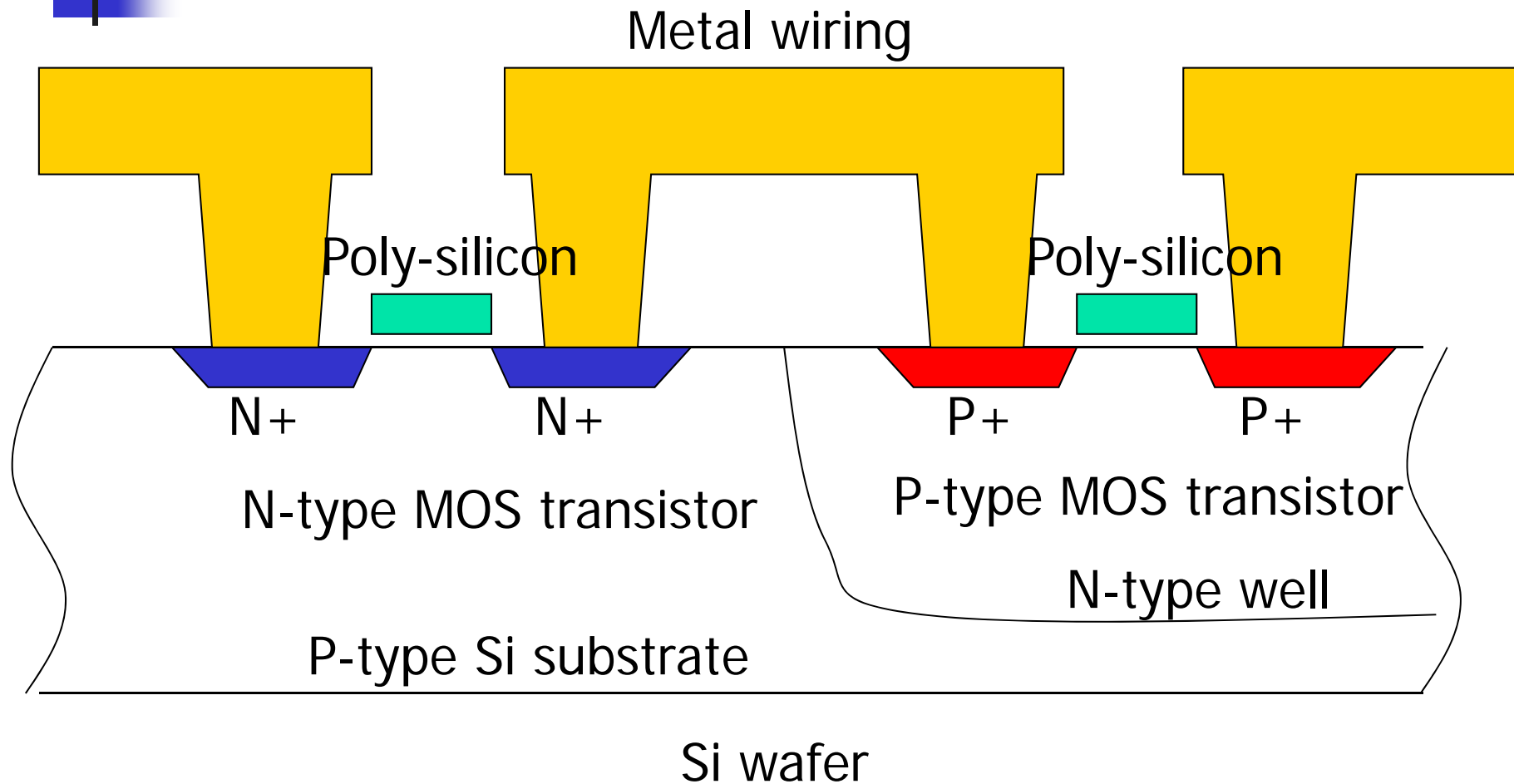

Advanced Process Development

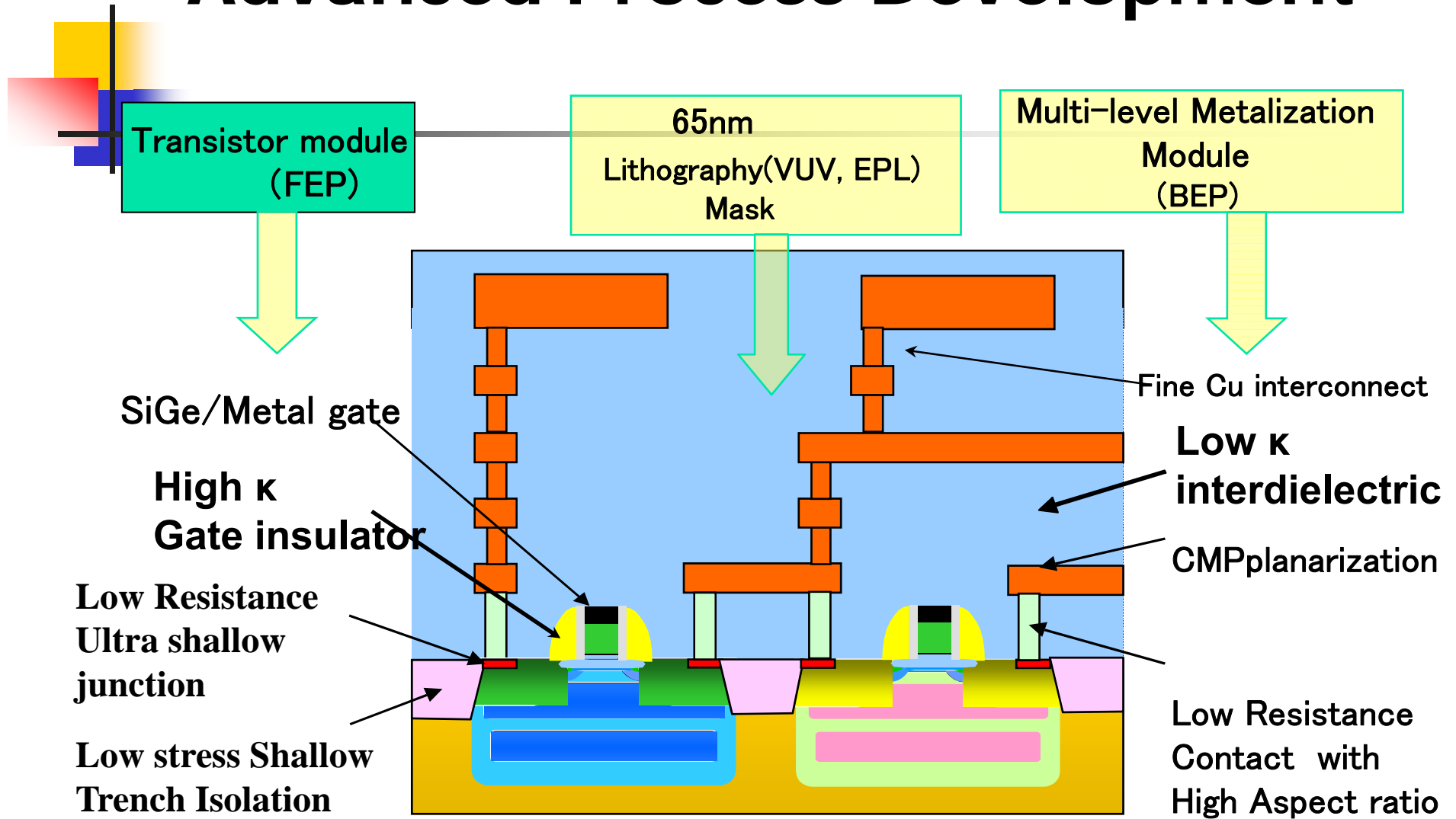

LSI integration trend

- Moore's law -

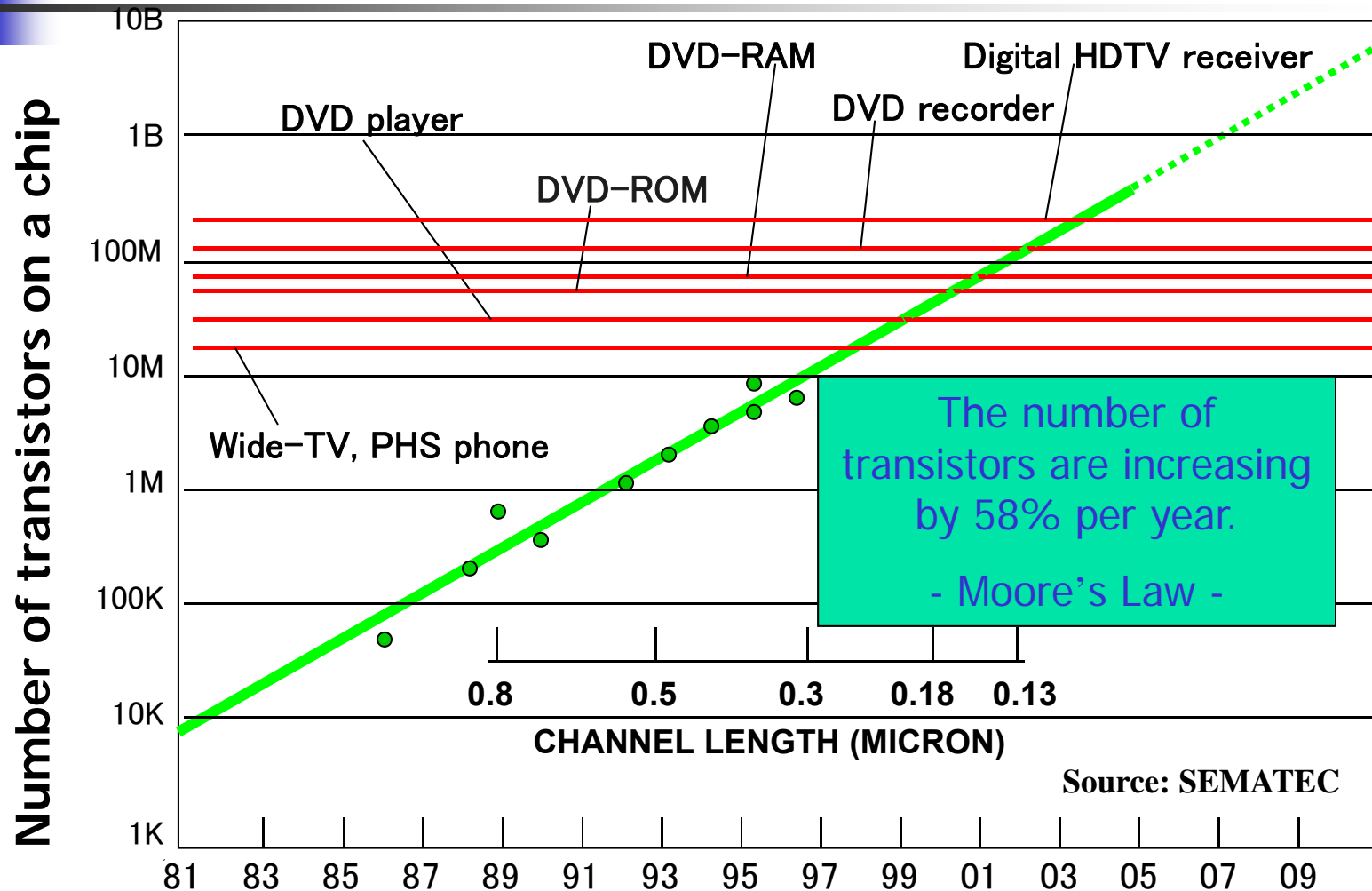

Communications and Consumer Products Drive Semiconductor

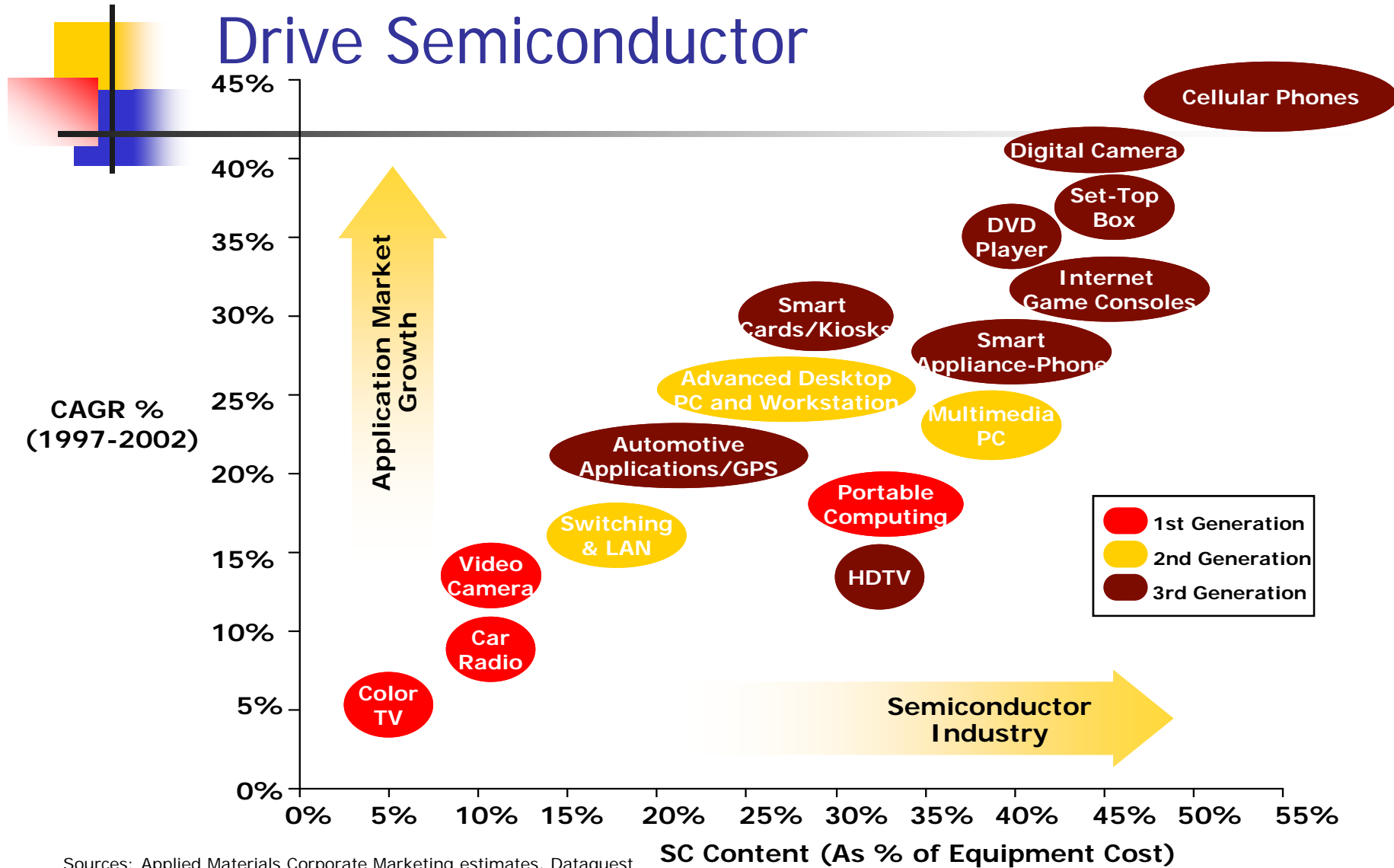

Sources: Applied Materials Corporate Marketing estimates, Dataquest

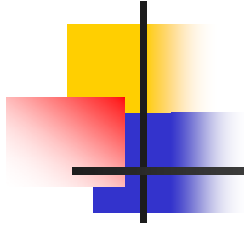

FABRICATION PROCESS ISSUES

Ultra Clean Room



Basic LSI process

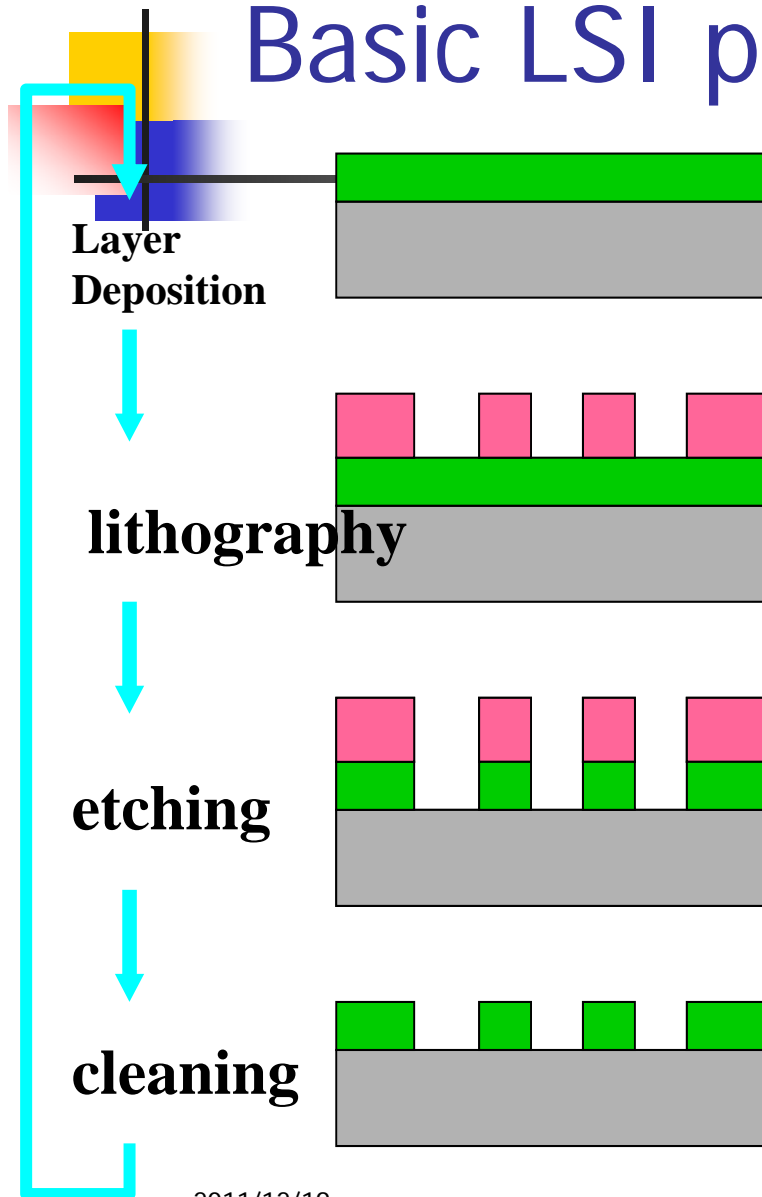

SEM photo of Logic LSIs

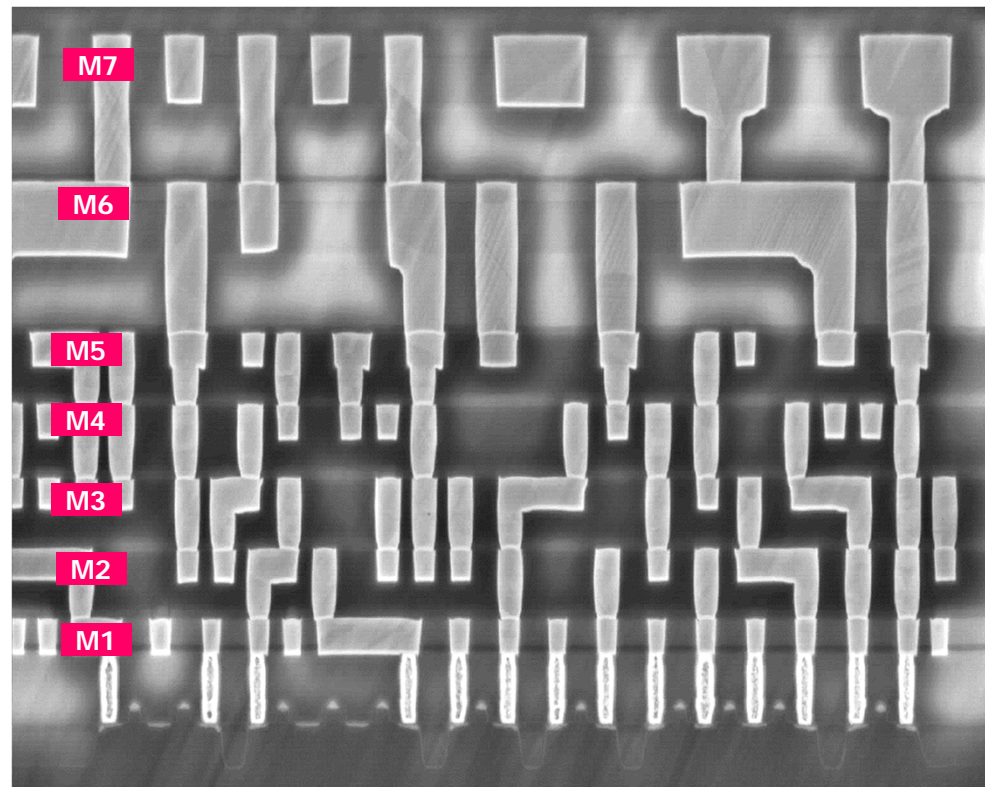

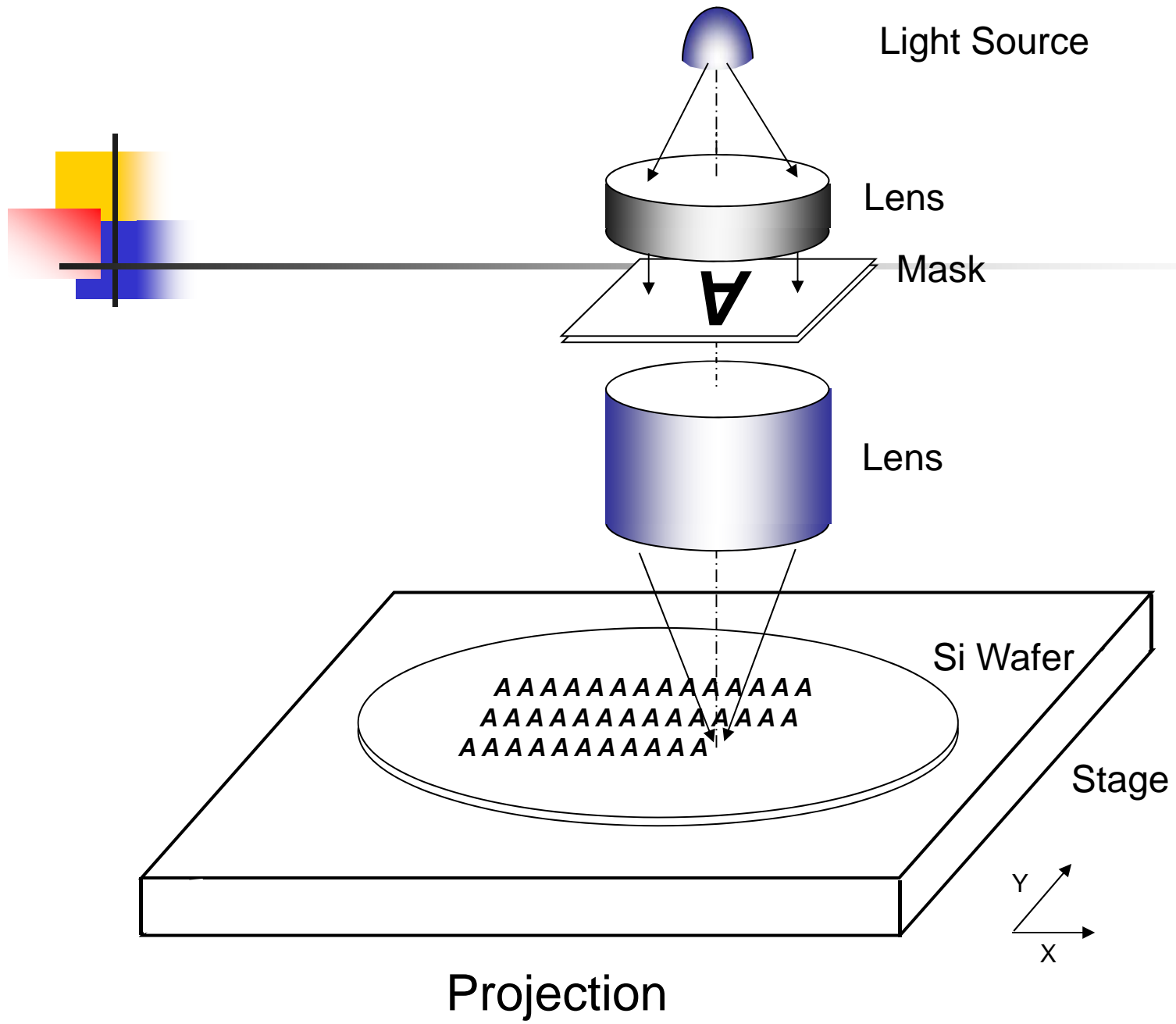

Packaging & Test

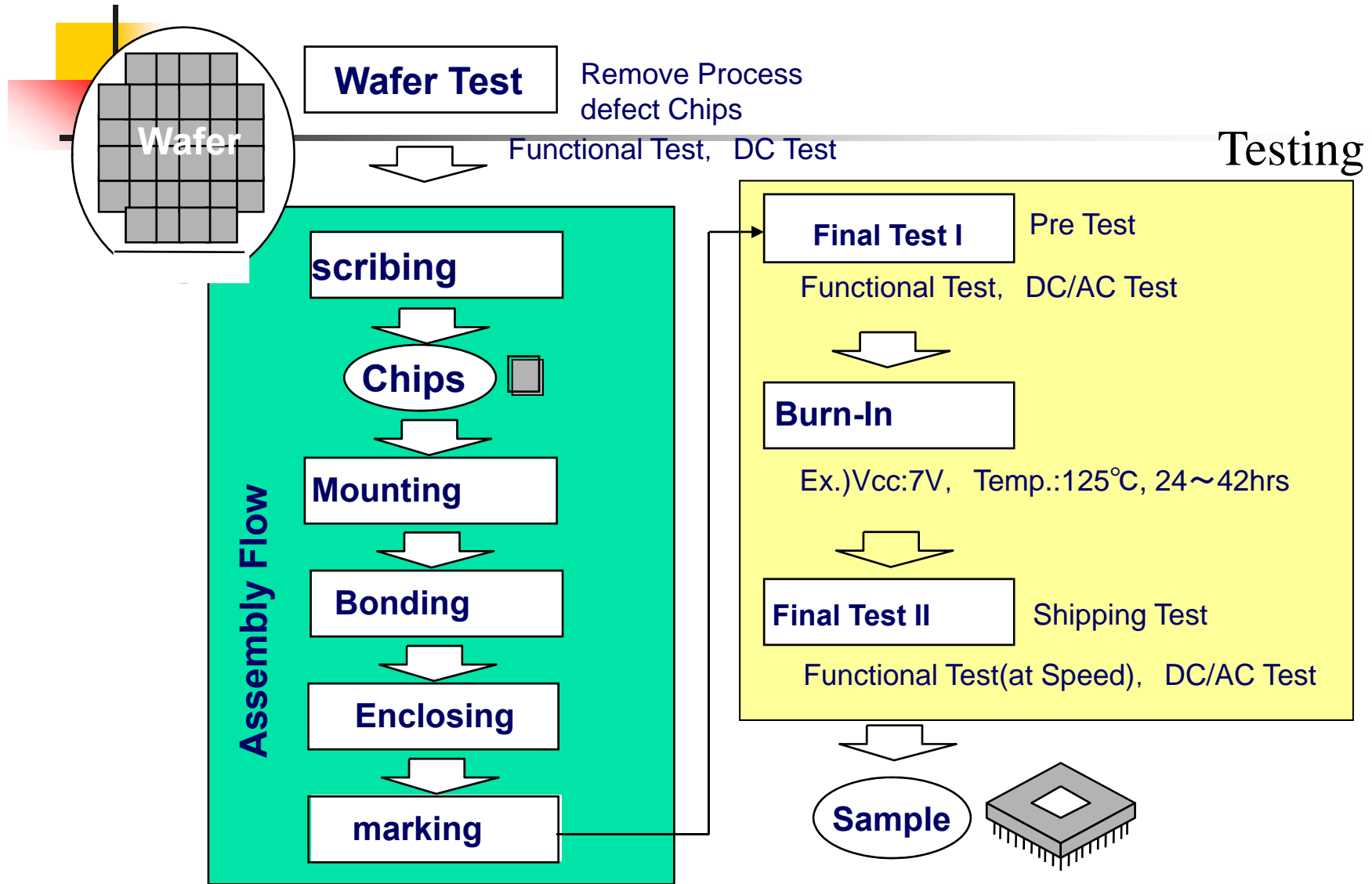



Large Scale Integration

- NMOS , PMOS and Wiring
 - All Logic Function can be made
 - Memory Element Can be made
- Billions of Transistors and wiring make LSI!

CMOS NOT (Inverter)

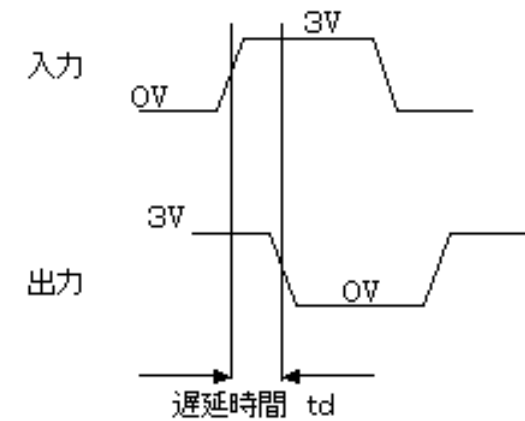
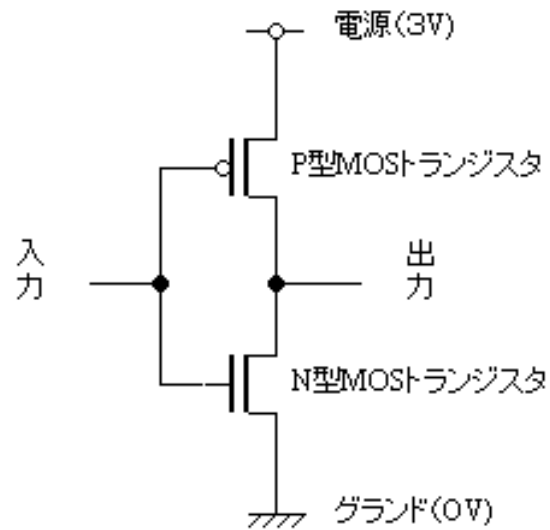
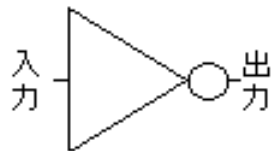

CMOS NAND と NOR

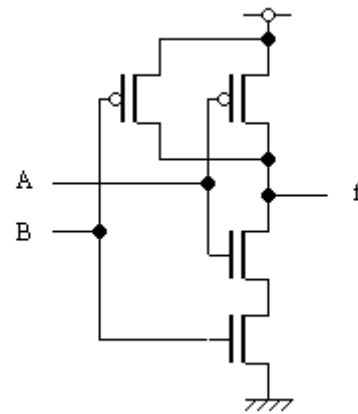
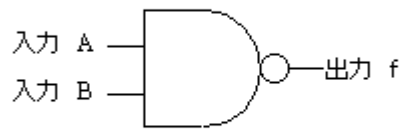

A	B	f
0	0	1
0	1	1
1	0	1
1	1	0

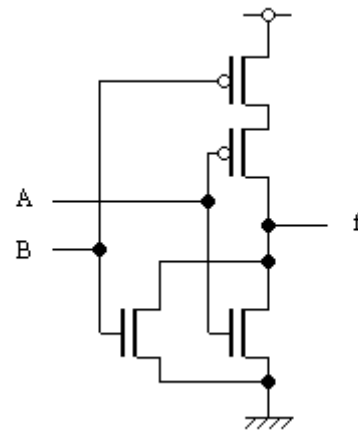
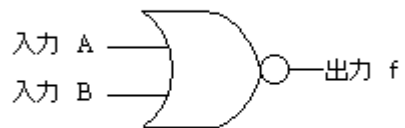

A	B	f
0	0	1
0	1	0
1	0	0
1	1	0



Classification Of LSI

1. Logic LSI: Micro Processor, **Digital Signal Processor (DSP), FPGA**
 2. Memory LSI: RAM (DRAM, SRAM), ROM (Flash Memory)
 3. Analog LSI: ADC, DAC, Filter, Amplifier
- Micro Processor (PC's central processing Unit)
 - Perform Digital computation according to the program in Memory
 - Integration in 7000 times in 25 years, (Moor's Law)
 - Clock Speed : 700 times in 25 years
 - Memory LSI:
 - Dynamic Random Access Memory: Main memory for Computer, 4-times density in 4 years
 - Static Random Access Memory : work memory for mobile equipments
 - Flash Memory : Nonvolatile memory , Digital Camera Storage
 - Analog LSI:
 - Used for interface, high speed RF interface, **Analog to Digital Conversion**, Digital to Analog Conversion

Analog to Digital Conversion

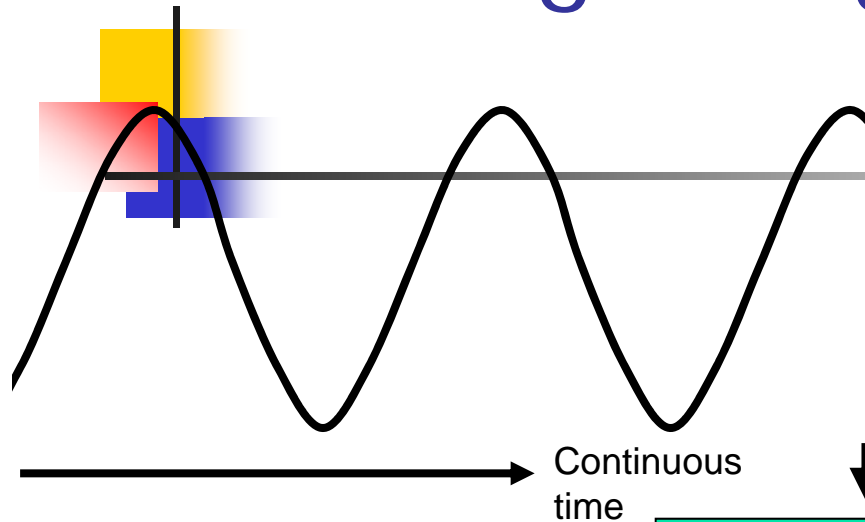

Analog to Digital

- Sample the analog wave
- Convert to Digital format in Binary
- Same as $f(t)$ to A_n

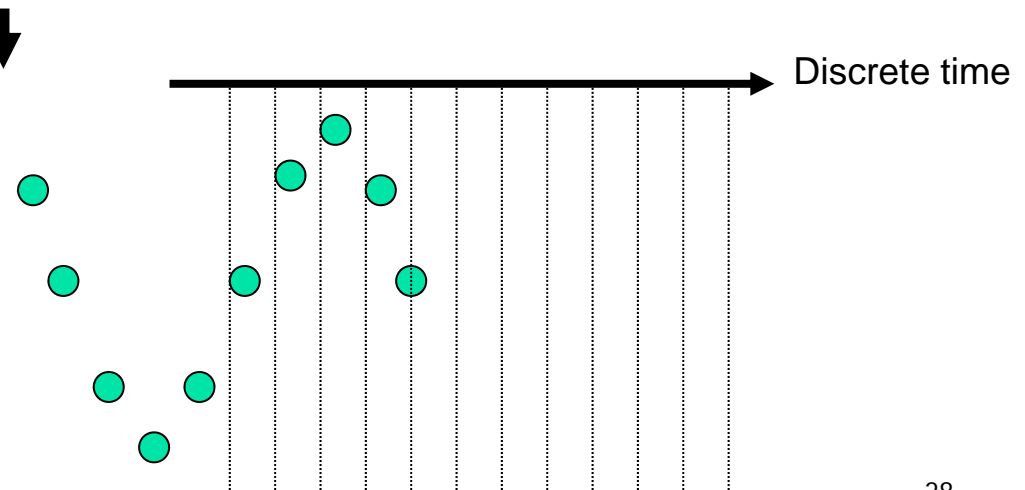

Chip photo 1

SoC

Flash Memory

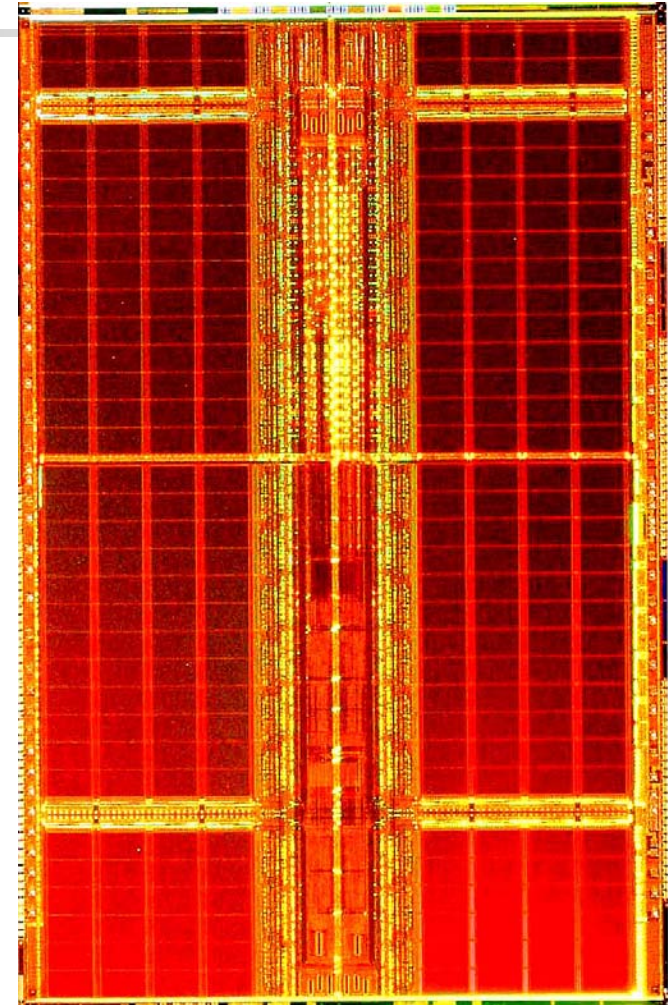
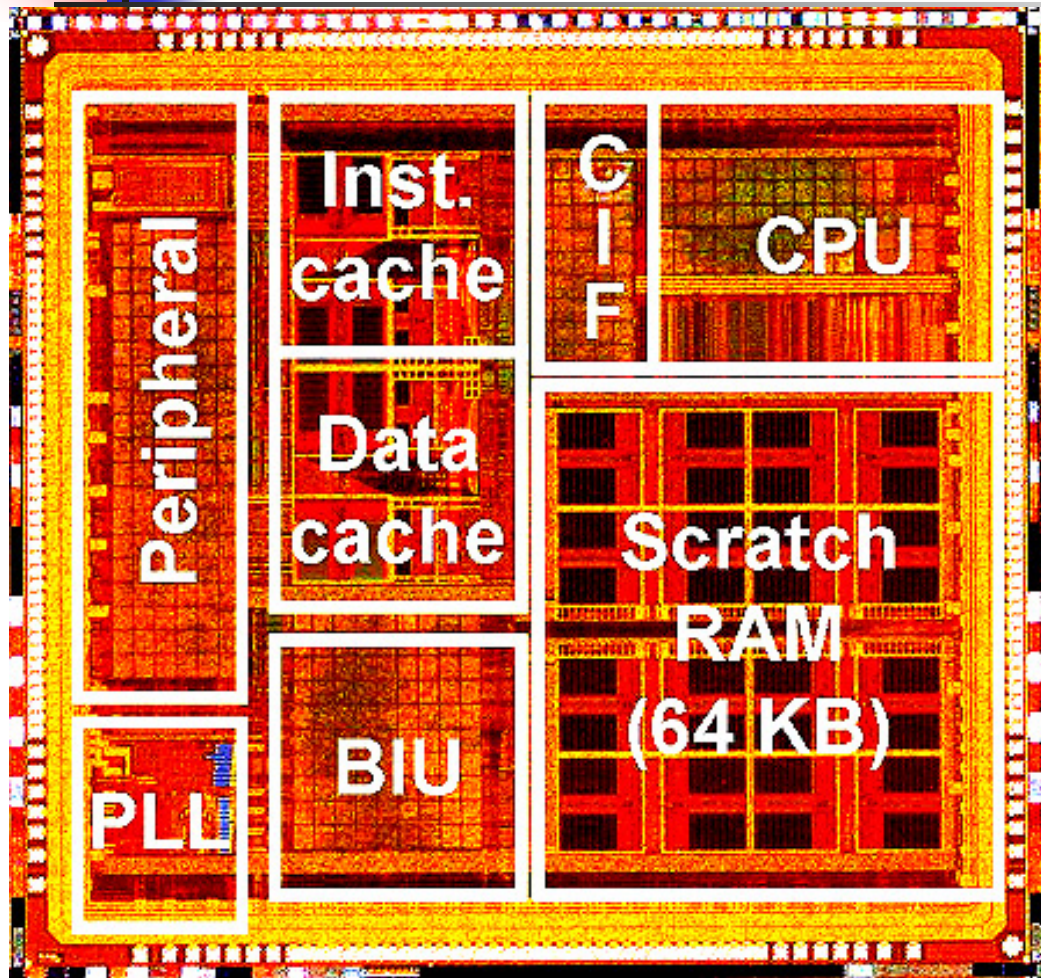

Chip photo 2

Mobile Digital TV receiver

